

FETCO® User's Guide and Operator Instructions

TEAVARIS PLUS
TEA BREWING SYSTEM

TBS-1221 and TBS/1222 Iced Tea Brewer FETCO TEAVARIS PLUS® Commercial Beverage Equipment



TBS-1221 Single Dilution Teavaris Plus



TBS-1222 Dual Dilution Teavaris Plus

Shown with ITD dispensers-not included



CONTACT INFORMATION

FETCO® FOOD EQUIPMENT TECHNOLOGIES COMPANY

600 ROSE ROAD

LAKE ZURICH • IL • 60047-0429 • USA

ON THE WEB: fetco.cofee

©2021 FETCO

PATENTS: <https://www.fetco.com/pl/pages/patents/74.html>



fetco.com

PHONE: (800) 338-2699 (US & CANADA)

(847) 719-3000 (All Countries)

FAX: (847) 719-3001

EMAIL: sales@fetco.com

orders@fetco.com (to order parts and equipment)

techsupport@fetco.com (all service queries)

August 2021

P209

Iced Tea Brewer: TBS-1221, TBS-1222

TABLE OF CONTENTS

Specifications and Requirements	2
Starting The Brew	4
Enter Programming	4
A PROGRAM	6
B GENERAL	8
C SERVICE INPUTS	9
D SERVICE OUTPUTS	9
E CALIBRATION	10
F SERVICE MENU	11

F ERROR CODES	12
G COUNTERS	13
H SAVE & EXIT	14
Operator Training	15
Parts Diagrams	18
Small Spray Head Assembly	23
Brew Baskets Parts Lists	24
Wiring Diagram	25

Specifications and Requirements

Water Requirements:

Water inlet fitting is a 1/4 inch male flare.(Page 16)
 Pressure: 20-75 psig, (138-517kPa) 1½gpm/(5.7lpm)
 For Iced tea: brewer is factory calibrated to a non-fluctuating stable water supply pressure at 45 psi.
 Water supply: (Optimal) 100-150TDS
 All beverage equipment must use filtered water

Brew Volume-Iced Tea: Full Batch 3 gallons/11.40 liters
 User adjustable to up to 4.9 gallon/18.7 liters per brew
 Brew batch and dilution ratio user adjustable

Electrical: Supplied with 120V cord & plug

Tank Temperature, as set by factory:
 200°F (93°C) inside water tank (at sea level)

Iced Tea Batch Temperature-user adjustable
 200°F-207°F-/ 93°-98°C

Iced Tea Dilution Ratio: 1:4 factory set brew to water
 Factory setting adds 2.4 gallons of cold water to 0.6 gallon brew for a 1:4 ratio Iced tea
 (2.3liter brew/9.1 liter dilution)
 Dilution volume is user adjustable from 0-4Gal;0-15.2L

Total Brew Cycle—Iced Tea-(Batch 1)

6:45 minutes=[3:00 minute brew time + 1:30 minute drip delay + 0:10 dilution delay + 3:35 dilution]

Batch 2 and batch 3 may be enabled and will set by machine for batch 1 by default or as defined by user

Brew-Process parameters are user controllable for: Brew Volume, Brew Time, Prewet Percent and Delay,

Drip Delay, Tea Batch Temperature, Dilution Volume and Dilution Timing (with brew or after brewing)

Coffee Filter FETCO# F001 or 15" X 5 ½ "

Dose: 2.5 oz to 4.0 oz

Single dilution brewer has a square plastic brew basket with set of nine orifices

Electrical Specifications for single domestic- 120 volt cord and plug

SKU	Dilution	Electrical Connection	Heater Configuration	Voltage	KW	Amp Draw	Est.3gal Batches/Hour
T1221US-1A117-PM001 Domestic	Single	NEMA 15-5P	1 X 1.7 kW	100-120	1.2-1.7	12.3-14.7	6

Electrical Specifications for single International- CEE 7/7 "Shucko" cord and plug

SKU	Dilution	Electrical Connection	Heater Configuration	Voltage	KW	Amp Draw	Est. 11.4 L Batches/Hour
T1221IN-1B130-PN005	Single	CEE 7/7	1 X 3.0 kW	200-240	2.1-3.0	10.9-13.0	8-9
T1221CE-1B130-PN005 CE	Single	CEE 7/7	1 X 3.0 kW	230	2.8	12.5	9

Dual dilution brewer has a round brew basket to change the brew position from left to right for the dual dilution option.

Note: The "D" in the SKU is for dual-dilution.

Electrical Specifications for Dual domestic- 120 volt cord and plug (Round plastic brew basket with set of nine orifices)

SKU	Dilution	Electrical Connection	Heater Configuration	Voltage	KW	Amp Draw	Est.3gal Batches/Hour
T122DUS-1A117-PN001 Domestic	Dual	NEMA 15-5P	1 X 1.7 kW	100-120	1.2-1.7	12.3-14.7	6

Electrical Specifications for Dual International- CEE 7/7 "Shucko" cord and plug

SKU	Dilution	Electrical Connection	Heater Configuration	Voltage	KW	Amp Draw	Est. 11.4 L Batches/Hour
	Dual	CEE 7/7	1 X 3.0 kW	200-240	2.1-3.0	10.9-13.0	8-9
T122DCE-1B130-PN005 CE	Dual	CEE 7/7	1 X 3.0 kW	230	2.8	12.5	9

Weights and Capacities

Model	Height	Width	Depth	Water tank capacity	Empty Weight	Filled Weight	Shipping Weight	Shipping Dimensions
TBS-1221 Brewer	36 5/8 in 930 mm	9 1/4 in 235 mm	22 in 560 mm	2.7 gallon 10.1 L	35 lbs 15.9 kg	60 lbs. 27.2 kg	50 lbs. 22.7 kg	39 x 27" x 11.5" 991mmX686X292mm
TBS-1222 Brewer	36 5/8 in 930 mm	9 1/4 in 235 mm	22 in 560 mm	2.7 gallon 10.1 L	37 lbs 16.8 kg	62 lbs. 28.1 kg	52 lbs. 23.6 kg	39 x 27" x 11.5" 991mmX686X292mm

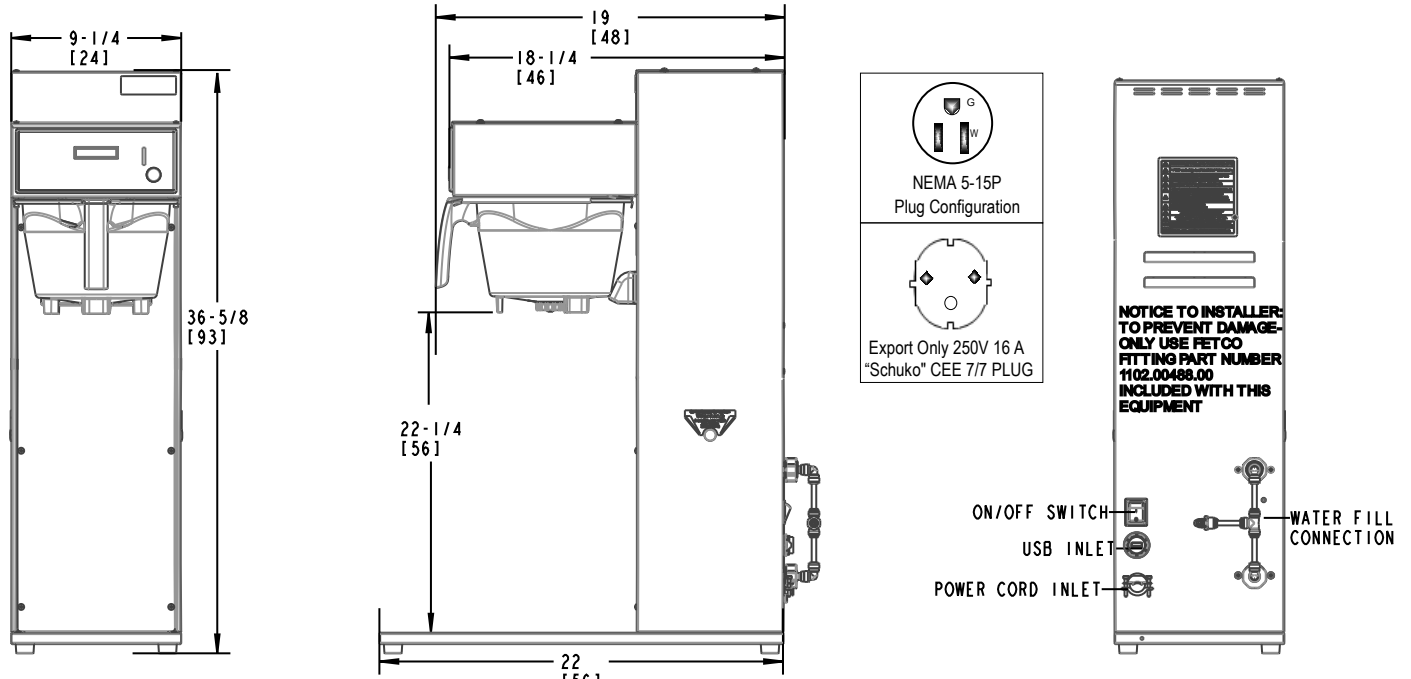

TBS-1221/1222 Front

TBS-1221/1222 Side

Back panel connections and advisories

TBS-1222 Dual dilution brewer uses the position of the brew basket handle to select the recipe from the six recipe group. Left orientation is recipe group A1, A2 and A3. Right hand position is recipe A4, A5 and A6. Position a receiving dispenser for the left or right side brew orientation.

TBS-1221 Single dilution has a square brew basket and is only positioned in the center for three recipes A1, A2, and A3.

Two position brew basket -Position of the brew basket handle left or right sets brew side (Dual model only)

Dual Model Only
Brew basket handle—LEFT
Batches A1, A2, A3

(For left hand dispenser placement)

Dual Model Only
Brew basket handle—RIGHT
Batches A4, A5, A6

(For right hand dispenser placement)

Single Model Only
Brew basket handle—CENTER
Batches A1, A2, A3

(Position dispenser in center)

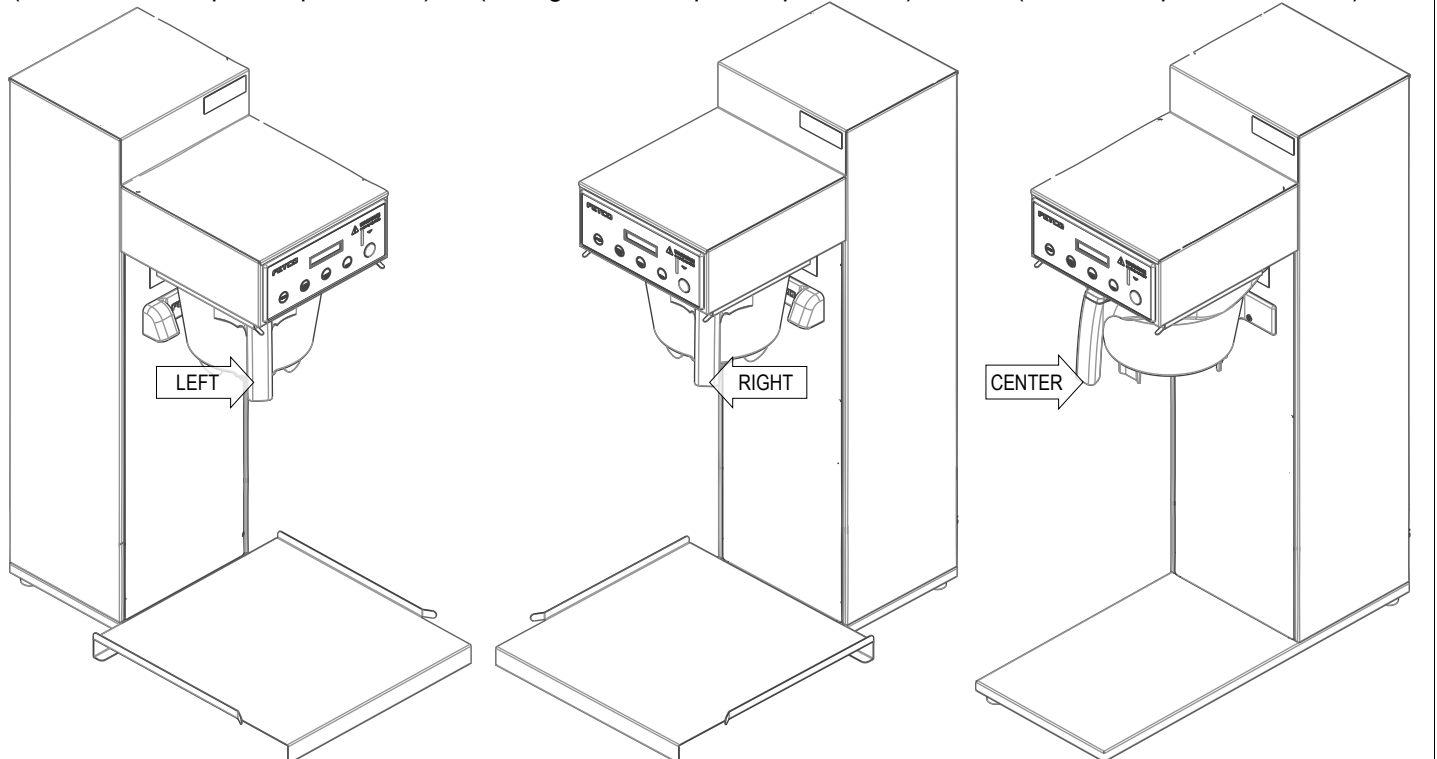

Starting The Brew

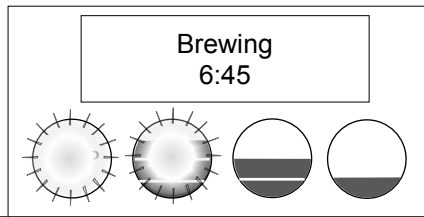
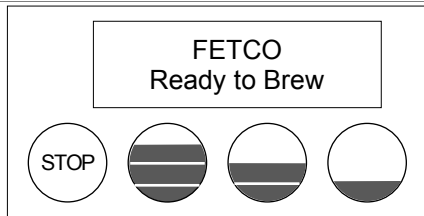

1. Turn the power switch "ON".
2. Prepare a brew basket with the correct size filter and appropriate amount of tea.
3. Slide the brew basket completely into the rails.
4. Place a clean, empty, dispenser under the brew basket.
5. Select a batch & hold the corresponding BREW button in for 1 second to start
6. -STOP button will illuminate, Brew Selector button will illuminate
-Countdown time will display. Default time setting is 6:45(iced tea)
-Selected BREW button will slowly pulsate to indicate brew is in progress.
-All other BREW buttons for that brew head will be unlit.
7. Dilute DELAY cycle will activate at 3:45
8. Dilute will activate at 3:30.

Upon time out, brewer will return to "READY" for next batch
STOP button will extinguish and the BREW button will illuminate on completion
For safety- do not remove brew basket until drip-out is complete.

Enter Programming

There are 7 menu groups-A-F plus EXIT (G).

See the following pages for the batch parameter definitions and all settings for the brewer

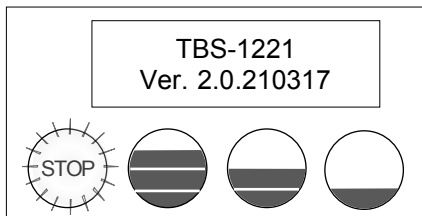

TO ENTER PROGRAMMING

- 1-Turn brewer "OFF" from power switch
- 2-Turn power switch to "ON"

...Screen will initialize and then display digital process notifications

- 3-After Initialization- "STOP" Lamp turns on
- 4-Quickly press "STOP" button (no need to hold)

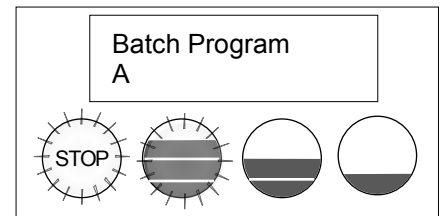
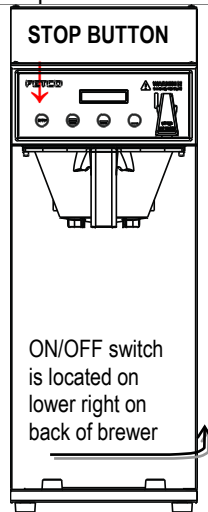

When brewer is In PROGRAMMING MODE

-the screen will display:

BATCH PRG!
A (or B-F)

-Illuminated LED indicates active keypad positions

See the following pages for batch parameter definitions and all settings for the brewer

Enter Programming to Make Changes Section B – "General Settings" to change tank temperature shown below

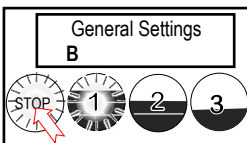

Enter Programming-Press STOP button until the General Settings ("B") screen appears

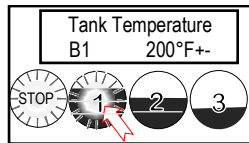

From the "B" screen Press button **1** to toggle to the Tank Temperature Screen (default is 200°)

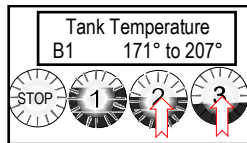

From Tank Temp screen Toggle buttons **2** & **3** to select the desired temperature

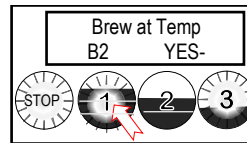

From Tank Temp screen Press button **1** to toggle to the next selection in General Settings or SAVE

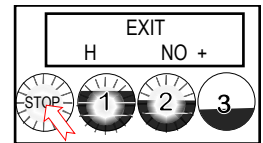

To SAVE and EXIT Press the STOP button to the "H" screen. Proceed to screen two below

See the program menu layout table on the next page to locate the desired control settings to adjust.
Batch size and menu brewing parameters are in section "A".
The most common settings for tank temperature setpoint, units of measure are in section "B".

Programing Menu Layout

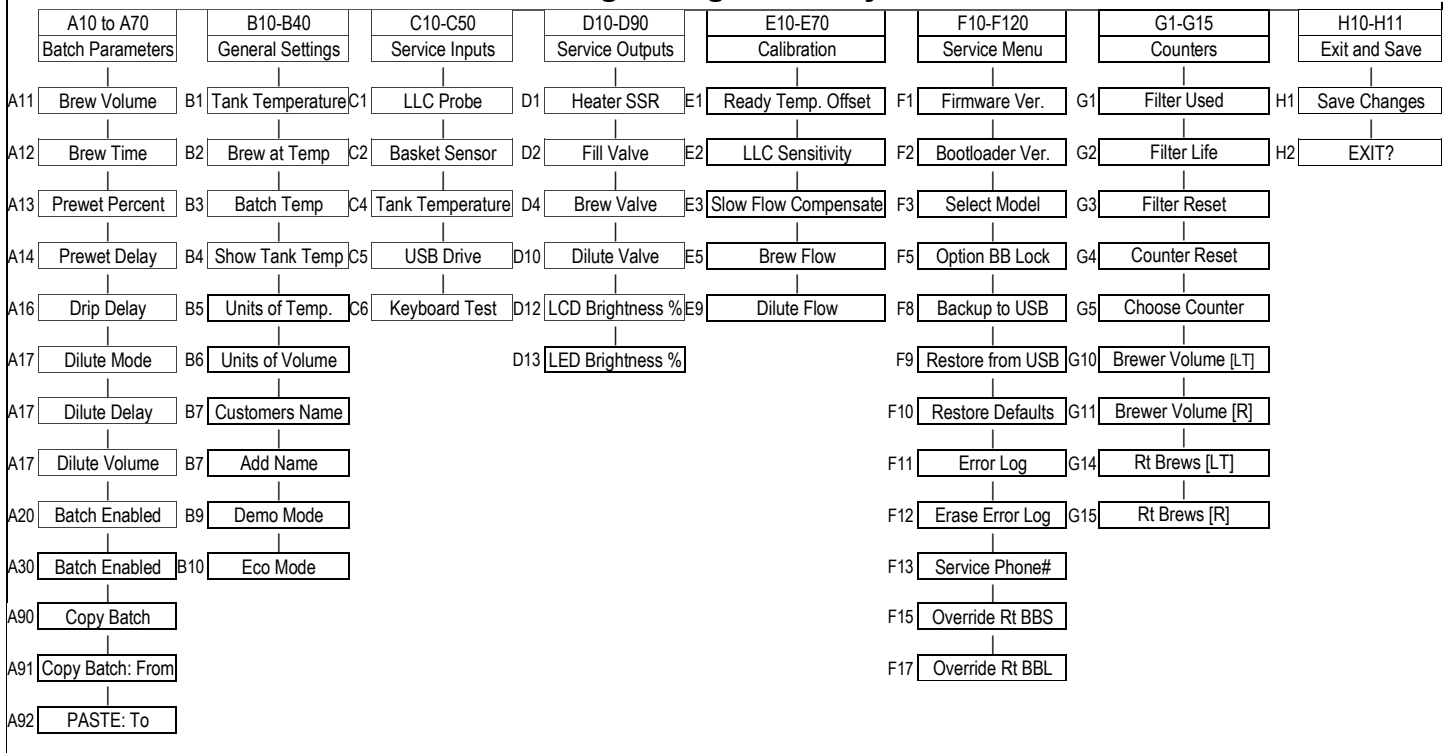

Do not exit Programming by turning brewer off/on, all settings will be lost.
Follow the steps shown in the chart below to exit and save settings.

Exit Programming & Save Settings and Changes Control Setting Changes

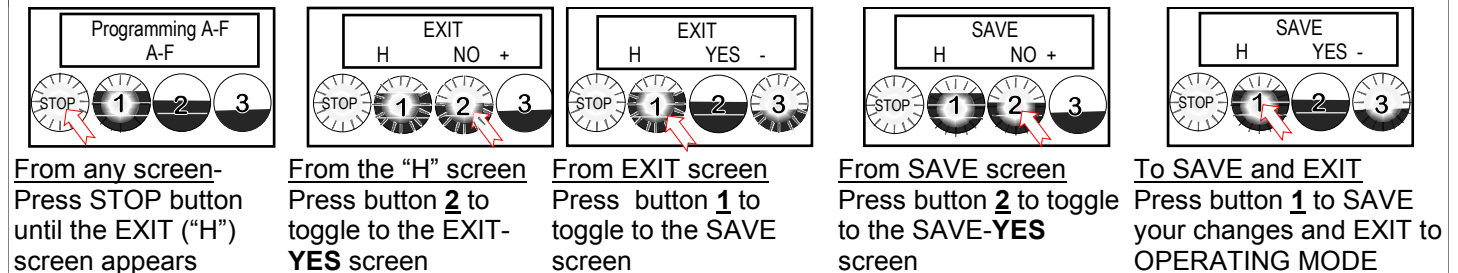

A PROGRAM Menu Features: Batch Parameters

The settings below are shown for the top batch on a single brewer top left button on a twin brewer.
See how to access all A menus on the previous page. Below are the brew settings for default A1 & A2 batches

POSITION	Program Items	Factory set Default	Programming Range	Increments	Notes
A11	Batch Volume	78 Oz 2.20liters	33 oz to 135oz 0.94 to 3.9L	1 oz 0.05L	Software is in fl, ounce; Can convert to liters/gallons
A12	Brew Time (MIN:SEC)	3:00 minutes	2:00 – 12:00	30 sec	Default total brew time is 5:00 minutes
A13	Prewet Percent	0%	0.00 – 25.0%	1%	Percentage of total brew volume
A14	Prewet Delay (Pause after prewet completes)	0% [1:00 Min]	[0:10 – 5:00]	30 sec	The time between prewetting and start of brew cycle. This feature appears ONLY if Prewet >0:00
A16	Drip Delay	1:30 mm:ss	0:30 – 6:00 min.	10 sec	Time brew basket should remain in place during final drip-out →Drip delay remains “ON” for 2:00 minutes if STOP is pressed during brew †
A170	Dilution Mode	Normal	Normal/Fast		NORMAL: Dilution after the brew is completed FAST: Dilution is during the brew cycle
A171	Dilution Delay (not available for FAST dilute)	0.10	0:00 –12:00 min	10 sec	Pause after brew to begin dilution. Often used to add sweetener
A172	Dilution Volume	308 oz 9.1 liters 2.4 gallons	1-512oz 0:00 –15:15 liters 0:00 –4:0 gallons	1 oz 0.05L 0.01G	Unit default is fluid ounces. Can be set for liters and gallons.
A190	Batch Temp.	200°F (93°C)	200-207°F	1 degree	Used to set brewing temperature for individual batches (only if B-2 is on)
A20	Batch Enabled A20 YES - NO +	NO	OFF/ON	Select	Batch presets as above
A30	Batch Enabled A30 YES - NO +	NO	OFF/ON	Select	Batch presets as above
A4.00	Batch Volume	78 Oz	33 oz to 135oz	1 oz	See A11 - above
A4.20	Brew Time (MIN:SEC)	3:00 minutes	2:00 – 12:00	30 sec	See A12 - above
A4.30	Prewet Percent.	0%	0.00 – 25.0%	1%	See A13 - above
A4.40	Prewet Delay	0% [1:00 Min]	[0:10 – 5:00]	30 sec	See A14 - above
A4.60	Drip Delay	1:30 mm:ss	0:30 – 6:00 min.	10 sec	See A16 - above
A4.70	Dilution Mode	Normal	Normal/Fast		See A170 - above
A4.71	Dilution Delay	0.10	0:00 –12:00 min	10 sec	See A171 - above
A4.72	Dilution Volume	308 oz	1-512oz	1 oz	See A172 - above
A4.90	Batch Temp.	200°F (93°C)	200-207°F	1 degree	See A190 - above
A50	Batch Enabled A50 YES - NO +	NO	OFF/ON	Select	Batch presets as above
A60	Batch Enabled A60 YES - NO +	NO	OFF/ON	Select	Batch presets as above
A90					
Copy Batch A91 Copy From	Copy From Batch	1 +	A91 1 (1-6)		Select recipe to copy
A92 (PASTE TO)	Paste To Batch?	1 +	A92.1 (1-6)		Select where to paste

A20 and A30 (middle and right batches) are shipped disabled may be enabled by user.

† **DRIP DELAY** will not activate when STOP is pressed within 5 seconds of starting a brew time

Batch A locations for programming

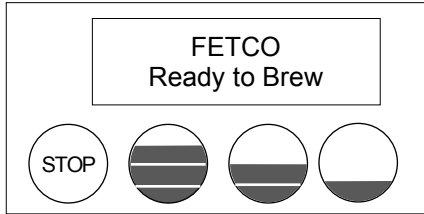

SINGLE & DUAL **Batch A1 Batch A2 Batch A3**
 DUAL ONLY **Batch A4 Batch A5 Batch A6**

The A menus A1-3 (single) A1-6 (dual) correspond to the three batch buttons on the touch panel
 Access the A menus to PROGRAM & make changes to individual menu recipes. Menu settings can be copied
 Menu position A1 (single) & A4 (dual only) is permanent. Menu A2 & A3 (A5 & A6-dual) are enabled by as desired

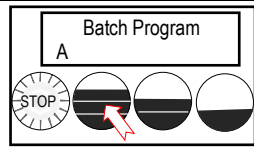

From A PRG screen
 Press button 1 to go to the A menu access screen

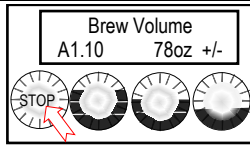

From A11 screen
 Press **STOP** to scroll to A20.
 (A1 is permanent)

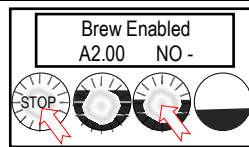

Press the third button to enable the batch, if desired. The recipe is factory defaulted as recipe 1.10

From A20 screen
 Press **STOP** to scroll to the third batch in the "A" menus. Make any changes as required

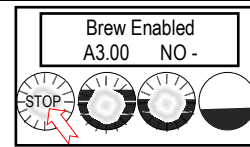

Press the third button to enable the batch, if desired. Recipe is factory default as recipe 1.10

From A30 screen
 Press **STOP** to scroll through COPY and further to remaining programming keys.

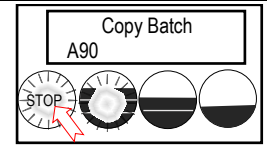

To continue
 Press STOP to scroll through more sections
 See SAVE & EXIT on page 5 or 14

...For TBS-1222 only, proceed to A4, A5 and A6 to program the left side

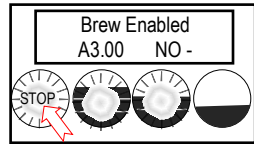

From A3.00 screen
 Press STOP to scroll to A4:00

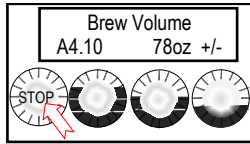

A4.00 is permanently enabled. It is factory set for the same parameters as A1.10

From A4.0 screen
 Press **STOP** to scroll to the next menu

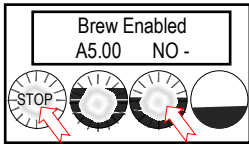

Press the third button to enable the batch, if desired Recipe is factory default as recipe 1.10

From A5.0 screen
 Press **STOP** to scroll to the next menu

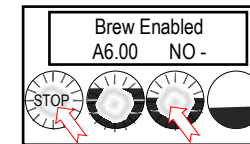

Press the third button to enable the batch, if desired Recipe is factory default as recipe 1.10

From A6.0 screen
 Press **STOP** to scroll to the next menu

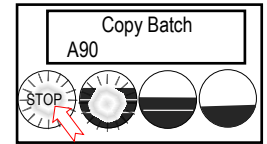

From A90 press once more to access menus B-H

Be certain to "SAVE" changes if recipes are modified or programmed.
 See page 5 or 14

B GENERAL Brewer Operation Control Settings, Adjust Brew Flow Rate					
POSITION	Program Items	Factory set Default	Programming Range	Increments	Notes
B1	Tank Temp.	200°F-or-93°C	170° to 207°F 77° to 97°C	1.0°F 0.5°C	Chart to correct for high altitude below
B2	Brew at Temp.	“YES”	ON/OFF	YES/NO	SEE NOTE BELOW
B3	Batch Temp	OFF	ON/OFF	ON/OFF	For tea brewing temperature for A190
B4	Show Tank Temperature	YES	YES/NO		To display HW tank temperature on screen
B5	Units of Measure TEMPERATURE	° Fahrenheit	Fahrenheit/Celsius	C/F	NOTE: Overwrites user settings (see page 9)
B6	Units of Measure VOLUME	Ounces	Ounces/Liters/Gallons	Oz/L/Gal	NOTE: Overwrites user settings (see page 9)
B7	Customer Name	Off	NO or YES		For name on screen
B8	Customer Name	(only if above is “ON”)	Scroll with batch keys	A-Z;a-z;0-9	16 characters total
B9	Demo Mode	OFF	DEMO ON/OFF		Demonstrates the controls for training. Disables all components in demo mode
B10	Eco Mode	Off	ON/OFF	YES/NO	If Selected: Lowers hot water tank temperature after preset time of inactivity
B11	Eco Idle Time (turns on if B10 active)	1Hr	1-6 hours	1 hour	Time of inactivity to go into ECO Mode
B12	Eco Idle Temp (turns on if B10 active)	169°F	158-176°F	1 degree	Temperature that hot water tank is lowered to
B13	Filter Life	OFF	ON/OFF	YES/NO	Water filter life is accessed in G-Counters. This is user set and will display indicator to change water filter

BREW AT TEMPERATURE DEFINITIONS

DEFAULT: BREW AT TEMP: “ON”

(FACTORY DEFAULT FOR BREWER)

“BREW at TEMP:
 -Batch will not start if tank temperature is below set point.
 -Display will show “HEATING” and hot water tank temperature
 The “BREW START” entry buttons will not illuminate until the hot water tank reaches the selected temperature.

Notifications shown on screen:
 TEXT: **HEATING**→Tank above 87°C/189°F- will allow brew at low temperature.
 Extracted tea flavor may be affected
 TEXT: **L. HEAT**→Tank above 76°C/169°F- will allow brew at low temperature.
 Tea flavor will be noticeably affected

Tank temp→
 STOP is not lit → & BREW START buttons not lit. and **are disabled.**

Batch menu button(s) will illuminate and “READY” will display on screen when hot water tank temperature is at setpoint

Hot water tank not at brew temp setpoint.

USER SELECTABLE OPTION: BREW AT TEMP: OFF
(Not recommended) Unit will operate at reduced temperature
 Allows brewing at any temperature above 169°F/76°C

[ft]	[m]	Suggested Setting[°F]	Boiling point[°F]	Suggested Setting[°C]	Boiling point[°C]
0	0	205	212.0	96	100.0
500	152	205	211.0	96	99.5
1000	305	200	210.1	93	98.9
2000	610	200	208.1	93	97.8
2500	762	200	207.2	93	97.3
3000	914	200	206.2	93	96.8
3500	1067	197	205.3	92	96.3
4000	1219	195	204.3	91	95.7
4500	1372	194	203.4	90	95.2
5000	1524	194	202.4	90	94.7
5500	1676	193	201.5	89	94.2
6000	1829	192	200.6	89	93.6
6500	1981	191	199.6	88	93.1
7000	2134	190	198.7	87	92.6
7500	2286	188	197.8	86	92.1
8000	2438	187	196.9	86	91.6
8500	2591	185	196.0	85	91.1

C SERVICE INPUTS		Brewer Sensors and Keypad			
POSITION	Program Items	Factory set Default	Programming Range	Increments	Notes
C1	LLC Probe continuity	Direct read	TDS tank reading (water resistance)	≈850- LOW ≈1600-HIGH	Nominal values
C2	Brew Basket Sensor	Direct read	YES or NO		
C4	Tank Temperature	Direct read	Hot water tank temperature		Actual values
C5	USB Drive	NO			
C6	Keyboard Test	Calibrate	Checks buttons under membrane	YES/NO	Follow directions on the screen

D SERVICE OUTPUTS		Test Valves and Heaters; Set screen brightness			
POSITION	Program Items	Factory set Default	Programming Range	Increments	Notes
D1	Heater SSR Test	Press button 2 to test (button 1 stops test)	Activates heater Default is 10 sec..	Toggle +/- OFF or ON	Energizes Heater(s) WARNING! Service use only.
D2	Fill Valve Test	Press button 2 to test (button 1 stops test)	Activates valve Default is 10 sec.	Toggle +/- OFF or ON	Press To Test
D4	Brew Valve Test	(Press to test)	Activates valve Default is 10 sec.	Toggle +/- OFF or ON	Runs valve to verify flow. NOTE: Have container under brew basket.
D9	Lt Dilute Valve	(Press to test)		Toggle +/- OFF or ON	Press To Test
D10	Rt Dilute Valve	(Press to test)		Toggle +/- OFF or ON	Press To Test
Single series displays right side only Left Valve display is only for twin side brewer.					
D12	LCD Brightness	Brightness=90%	20-100%	5%	Adjust LCD screen brightness only-Not for LEDs under buttons
D13	LED Brightness	Brightness=60%	20-100%	5%	Adjust LED button brightness only-Not for the screen display LCD

E CALIBRATION		Brewer Sensors and Keypad			
POSITION	Program Items	Factory set Default	Programming Range	Increments	Notes
E1	Ready Temp. Offset	-3°F -2°C	-2° to -9°F -1° to -5° C	1°F 1°C	Compensates output to measured temperature
E2	LLC Sensitivity	NORMAL ("NORMAL" for most water)	HIGH (Biased for reverse osmosis water or very pure water)	NORMAL HIGH	Liquid level control sensitivity. High,(1300Ω) is for reverse osmosis water or very pure water.
E3	Slow flow rate from supply	OFF	OFF/ON	Toggle +/- YES or NO	Trims fill system for low supply or Flojet use
E5	Brew valve flow rate:	54oz/1.60L/0.42G	45-64oz 1.30-1.90Liter 0.34-0.52G	1oz 0.05L 0.013G	Adjusts flow rate by brew valve
E9	Dilute valve flow	86oz/2.55L/0.67G	38oz-112oz 1.75-3.30Liter 0.46-0.86G	1oz 0.05L 0.013G	Adjusts flow rate by dilution valve

Use this formula to compensate for minor discrepancies in actual volume versus programmed volume.

See "PROGRAM" E5 For valve settings and calibration. Factory set brew valve flow rates are in liter/min

$$\frac{\text{ACTUAL VOLUME}}{\text{PROGRAMMED VOLUME}} \times \text{CURRENT SETTING} = \text{NEW SETTING}$$

Default Brew Valve Flow Rate—TBS-1221 Brewers

TBS-1220	Oz /L/ G/minute	Range
Brew Valve FR	54/160/0.42	45oz-64oz
Dilute Valve FR	86oz/2.55L/0.67G	38oz-112oz

Set FR lower to increase volume,
Set FR higher to decrease volume.

Use the formula above to determine the correct setting

F SERVICE MENU		Software & Code View and Settings			
POSITION	Program Items	Factory set Default	Programming Range	Increments	Notes
F1	Display Firmware	2.1.210504			Displays current version [4/2021]
F2	Display Bootloader	2.0.210317			Displays current version [4/2021]
F3	Select Model	TBS-1221 Will need reboot	Scroll to brewer model Save & Exit	CBS-1221 CBS-1231, CBS-1232 CBS-1241, CBS-1242 CBS-1251, CBS-1252 CBS-1261, CBS-1262 MBS-1221, MBS-1251 TBS-1221, TBS-1222	NOTE: Overwrites all user settings (See below)
F5	Option BB Lock	NO	NO or YES		Enables brew basket lock
F8	Backup to USB		Follow prompts	Saves settings	Insert blank USB
F9	Restore From USB		Applies settings from USB		Insert USB Will need reboot
F10	Restore Defaults	NO	NO/YES		Reset to factory
When selecting F10-RESTORE DEFAULTS, save and exit programming (page 13). Brewer returns to factory defaults for your model and deletes all user inputted changes.					
F11	Error Log	Lists up to six codes, in order	1: ; 2: ;3: ;4: ;5: ;6: 1=Newest/6=Oldest LAST six errors only	Newest=first Oldest=last	See Error Code Chart for references
F12	Erase Error Log	NO +		Toggle +/- YES or NO	FACTORY USE ONLY. DO NOT RESET
F13	Service Phone #				Service
F15	Override Rt BBS	NO	NO/YES	Toggle +/- YES or NO	Disables brew basket sensor
F17	Override Rt BBL	NO	NO/YES	Toggle +/- YES or NO	Disables brew basket lock

F ERROR CODES			
DO NOT CLEAR ERROR CODES UNTIL ERROR IS IDENTIFIED AND CORRECTED			
→Contact factory or specialized personnel for error codes			
Code	Description	Possible Cause	Corrective Action
001	Software error-error on start up or corrupted software	Improper start-up or shutdown	Restart , if still fault: reload software
002	Internal flash corrupted internal data memory malfunction	Error found in cyclic redundancy check CRC	Restart , if still fault: reload software If not corrected :replace board
050	Short-circuit in temperature probe	Probe failure.	Replace probe.
051	Open temperature probe.	Bad probe connection, or probe failure.	Check all connections. Replace probe if necessary.
100	Initial Fill Error. Initial fill time took longer than expected after powering up.	Water supply flow rate is too low.	Watch for short potting during brew cycle. Investigate cause of low flow rate. (Clogged water filter...)
101	Error on refill-. Tank did not refill within expected time.	Water supply flow rate is too low.	Watch for short potting during brew cycle. Investigate cause of low flow rate. (Clogged water filter...)
200	Heating flatline-Tank is boiling	Heater is on, temperature is not rising/dropping	High elevation correction. Bad heaters or temperature probe or position
201	Heater open, high limit thermostat, or Solid State Relay (SSR) fault	Failure of heating element, SSR, high limit	Check and replace heating elements, SSRs, high limit devices if necessary.
202	Heater Shorted or Stuck SSR	Heater is off and heating SSR is stuck "ON"	Check ohms on heater (15-60Ω). SSR may be stuck in ON mode-replace SSR.
255	Keyboard [HID] error	Usually from longer than 10 se contact. Or faulty reassembly after service	Restart , if still fault: reload software. If mechanical: replace module
NO BSKT <u>Insert Brew Basket</u>		Brew basket must be in place This is a SAFETY FEATURE	Insert brew basket into brewer rails to enable brewer

G COUNTERS Brewer Usage, Water Filter Usage, and Statistics

ROLE: [LT]=Permanent total for lifetime of machine [R]=operator resettable [User]=Input needed from operator

Position	Counter	Program items	Role	Information	Increments	Notes
----------	---------	---------------	------	-------------	------------	-------

G1-G3 are for water filter maintenance. Filter Life readings (G1, G2, G3) must be activated in B13 GENERAL if they are not visible and the equipment has a water filter.

All beverage equipment must use filtered water and filter cartridges must be monitored for quality

G1	A, S, B	Filter Used	[User]	0G	Gallons/Liters	Amount of water passed through external water filter. For filter life
G2	A, S, B	Filter Life	[User]	2,625Gal 10,000Liters	25 gal 100 L	Upload published life of filter
G3	A, S, B	Filter Reset	[User]	NO	Toggle +/- ,Y or N	Reset when replacing external water filter
G4	A, S, B	Counter Reset	[User]	NO	Toggle +/- ,Y or N	Resets all resettable counters to zero
G5	A, S, B	Choose Counter		Factory set to BASIC	Basic= B Advanced= A Statistical= S	Stored brewer component activity.. See column 2, Counters , to identify where counters are located.

G10-G15 Number of brews and volumes handled. Available in BASIC counter only (G5)

G10	B	Brewer Volume	[LT]	Dispensed volume	Gallons/Liters	Total of brews and hot water dispensed
G11	B	Brewer Volume	[R]			
G12	B	Lt Brews	[R]	Left side brew total CBS-1242	Count	Total brews-Left side (CBS-1242 only)
G13	B	Lt Brews	[R]			
G14	B	Rt Brews	[LT]	Right side brew total	Count	Total brews-Right side
G15	B	Rt Brews	[R]			

G20-G55 component use cycles and volumes handled. Available in ADVANCED counter only (G5)

G20	A	Fill Cycles	[LT]	Hot water tank refill cycles	Count	Cycles of hot water tank refill
G21	A	Fill Cycles	[R]			
G22	A	Fill Volume	[LT]	Total volume of water for all brews	Gallons/Liters	Quantity of water for brews
G23	A	Fill Volume	[R]			
G28	A	Rt Brew Cycles	[LT]	Right brew valve operation on/off	Count	Totalized cycles of valve operation
G29	A	Rt Brew Cycles	[R]			
G30	A	Rt Brew Volume	[LT]	Right brew valve flow through volume	Gallons/Liters	Totalized volume through right valve
G31	A	Rt Brew Volume	[R]			
G44	A	Rt Dilute Cycles	[LT]	Count	Count	Totalized cycles of valve operation
G45	A	Rt Dilute Cycles	[R]			
G46	A	Rt Dilute Volume	[LT]	Dilutes valve flow through volume	Gallons/Liters	Totalized volume through dilute valve
G47	A	Rt Dilute Volume	[R]			
G50	A	Rt BBL Cycles	[LT]	Right brew basket lock operation on/off	Count	Totalized cycles of brew basket lock operation
G51	A	Rt BBL Cycles	[R]			
G52	A	Heater Cycles	[LT]	ON/OFF switching for heating elements	Count	Totalized cycles of heater switching
G53	A	Heater Cycles	[R]			
G54	A	Heater On Time	[LT]	Total ON time for heating element	Hour	Totalized heater ON time in hours
G55	A	Heater On Time	[R]			

G80-G91 See illustration below for batch button positions Available in STATISTICAL counter only (G5)

G80	S	Batch 10 Cycles	[LT]	Menu button selection and activation count	Count	Total brews-left side top button
G81	S	Batch 10 Cycles	[R]			
G82	S	Batch 20 Cycles	[LT]	Menu button selection and activation count	Count	Total brews-left side middle button
G83	S	Batch 20 Cycles	[R]			
G84	S	Batch 30 Cycles	[LT]	Menu button selection and activation count	Count	Total brews-left side bottom button
G85	S	Batch 30 Cycles	[R]			

H SAVE & EXIT

Saving changes and exiting PROGRAMMING

The brewer will save changes only from the "H" menu. **DO NOT** reboot brewer or toggle ON/OFF-exit as below.

TO EXIT PROGRAMMING & HOW TO SAVE CONTROL SETTING CHANGES

HOW TO SAVE CHANGES AND EXIT-*The brewer is in PROGRAMMING mode.*

A convenient way to access the steps is to remember to scroll to EXIT → YES and to SAVE → YES

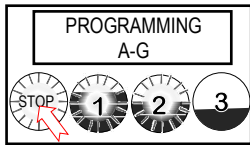

From any screen-
Press STOP button
until the EXIT ("G")
screen appears

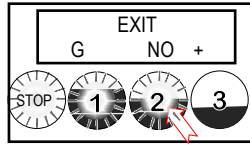

From the "G" screen
Press button **2** to
toggle to the EXIT-
YES screen

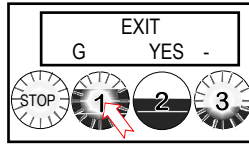

From EXIT screen
Press button **1** to
toggle to the SAVE
screen

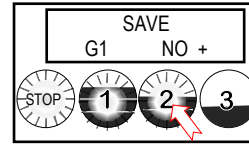

From SAVE screen
Press button **2** to
toggle to the SAVE-
YES screen

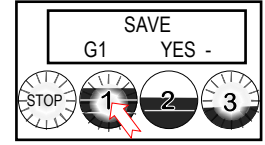

To SAVE and EXIT
Press button **1** to
SAVE your changes
and EXIT to
OPERATING MODE

NOTE: User Settings will be erased and overwritten to factory default settings by the following five programming changes

- 1) When setting or changing units of display for the tank temperature (F Fahrenheit or C Celsius). **(SETTING B5)**
- 2) When setting or changing units of display for the volume (L liters, G gallons). **(SETTING B6)**
- 3) When setting brewer model → The software sets equipment to brewer defaults **(SETTING F3)**
- 4) When loading from USB (Reprograms settings) **(SETTING F9)**
- 5) When restoring defaults (Reloads to defaults) **(SETTING F10)**

Operator Training

Review the operating procedures with whoever will be using the brewer.

Pay particular attention to the following areas:

1. Always use clean and sanitized dispensers for iced tea, demonstrate cleaning and sanitation procedures.
2. Make sure the dispenser is empty before brewing into it. Leave an empty dispenser in place when not in use.
3. Do not remove the brew basket from a brewer until it has stopped dripping.
4. Show how to attach covers, close, and or secure the dispensers for transporting.
5. Show the location and operation of the water shut off valve as well as the circuit breaker for the brewer.
6. Steam from the tank will form condensation in the vent tubes. This condensation will drip into and then out of the brew baskets. Up to 1/4 cup/118cc discharging overnight is possible. Place an appropriate container under each brew basket when not in use.
7. We recommend leaving the power to the brewer on overnight. The water tank is well insulated and very little electricity is used to keep the tank hot. Leaving the brewer in the "ON" position will also avoid delays at the beginning of shifts for the brewer to reach operating temperature.

Cleaning & Maintenance

After Each Brew:

1. Dispose of spent tea and rinse brew basket.
2. Never strike a brew basket or hit it against a hard surface.
This will damage the brew cone, and may damage the brew basket support rails
3. Rinse and sanitize dispensers before reuse. Do not hold tea at room temperature

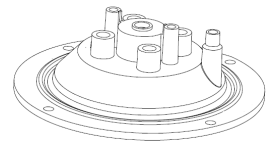

Every Day:

1. Wash brew basket with hot sudsy water.
2. Pull CSD from the spray head, it is magnetically attached. Use gloves or a heavy towel. → Wash off any film and reattach. Use vinegar if limescale filming is present.
3. Clean dispensers with hot suds water and a brush, rinse and air dry.
4. Use only a soft cloth and hot suds on the outside to avoid scratches. Never use abrasives that will scratch surface.

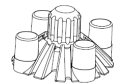

Weekly

1. Use a commercial tea dispenser cleaner such as URNEX™, TABZ™, DIP-IT™ or Squeak 'n Clean™.
2. Carefully Follow the instructions supplied with the cleaning product
3. Never use spray cleaners, solvent, solvent based cleaner or petroleum based polish anywhere on dispensers

Warning

1. Turn off power before any cleaning procedure, including wiping the exterior for appearance reasons.
2. Dry the exterior, especially the face panel, before turning on power.
3. Do not apply any type of spray cleaner on the face panel of this equipment.
4. Never use solvent or solvent-based cleaner or petroleum based polish anywhere on this equipment.
5. Dry the face of the touch pad before turning on power
6. Do not electrically energize this equipment or attempt operation without all covers in place and all screws fastened.
7. Unplug machine before disassembly or servicing.

Safety Notes

1. Professional installation is required. This appliance is manufactured only for commercial use
2. Operational requirements and maintenance for commercial cooking appliances differ from household appliances.
3. Operators must be trained for this equipment and must understand the use, maintenance and hazards.
4. Access to the service area is restricted to persons having safety/hygiene knowledge and practical experience of the brewer. This appliance must be installed in locations where it can be overseen by adult trained personnel.
5. Do not attempt to move hot beverage equipment once it is filled. Drain equipment before moving.
6. FETCO commercial brewers prepare large amounts of tea in a single batch using very hot water
7. Commercial brewers provide very hot water from the spray head, brew basket and faucet when it is pulled.
8. Brewers may continue to dispense very hot water after the electronic touchpad is completely disabled by turning off the power switch on the lower back of the unit or unplugging the unit.
9. For safety, the brewer control locks the brew basket for 6.5 minutes after starting the brew.
10. Never attempt to defeat the factory set (default) time that the brew basket is locked for safety from start of brew.

Keep these instructions for training and future reference.

General:

1. If not installed correctly by qualified personnel, the brewer will not operate properly, and damage may result.
2. Utilize only qualified beverage equipment service technicians for service and installation.
3. Always have an empty dispenser under spray head of all brewing equipment-including when at idle
4. Damages resulting from improper installation are not covered by the warranty and will void the warranty.

Below are the key points to consider before installation:

Electrical:

1. All CBS_Series brewers require **an electrical ground wire**. Installation without grounding is dangerous.
2. Note Equipotentiality Terminal, if present, (To identify the terminals which, when connected together, bring the various parts of equipment or of a system to the same potential, not necessarily being the earth (ground) potential, e.g. for local bonding.)
3. Verify voltages, polarity, circuits, and circuit breaker access before attaching equipment.
4. Brewers in this series wire differently in regard to a neutral wire. Review the wire diagrams.
5. The electrical diagram is located in the User's Guide and online at www.fetco.com.
6. Make sure of the tight grounding of the equipment and use the external ground bolt.
7. The installation must comply with applicable federal, state, and local codes having jurisdiction at your location. Check with your local inspectors to determine what codes will apply.

→See wiring diagrams for connections

Plumbing:

1. North America: All installations must comply with applicable federal, state, or local plumbing codes.
2. All Others: The water and waste piping and connections shall comply with the International Plumbing Code, International Code Council (ICC), or to the Uniform Plumbing Code (IAPMO).
3. Install a backflow prevention device. Most municipalities require a recognized backflow preventer
Usable on all hot beverage and cold beverage equipment is a WATTS® SD-2 or SD-3.
WATTS spring loaded double check valve models are accepted by most zoning authorities.
→The check valve should be as close to the water supply inlet of the beverage equipment as possible
4. All beverage equipment must use a water filter. A finishing carbon filter is preferred
5. Install the filter unit after a water shutoff valve and in a position to facilitate filter replacement.
6. The water line and newly installed filter cartridge must be flushed thoroughly prior to connecting it to the brewer to prevent debris from contaminating the machine
7. Verify that the water line will provide a flow rate of at least 1½gpm/(5.7lpm) per minute and the water pressure is between 20-75 psig (138-517kPa) before making any connections. TBS-1221 / TBS-1222 is factory calibrated to a stable, non-fluctuating water supply pressure at 45 psi
8. Only use the supplied factory adaptor (shipped in brew basket)to attach water supply line to both brewer fittings
9. The supplied fitting is a 1/4" flare.. Other fittings may be substituted for the flare fitting.
10. Hand tighten the factory fitting when connecting the stub on the brewer. This will reduce stress on the internal connections and reduce the possibility of leaks developing after the install has been completed

Tank Drain

The water tank must be drained before maintenance procedures, and when the unit is to be relocated or shipped.

Drain is for service use only and must not be permanently connected. NOTE: Never plumb a water line to the drain.

1. Disconnect power and water to unit. DANGER: Ensure that all utility connections to the brewer are broken.
2. Move the unit near a sink or obtain a container large enough to hold four gallons of water.
→Note: The hot water tank holds up to 2¾ gallons/10.1liters.
3. Remove the front panel and tank cover and allow the tank to cool to a safe temperature
4. The tank drain line and clamp are located inside-under the hot water tank. Pinch the drain line clamp to close
5. Locate the fill valve against the back wall, using pliers, loosen the hose clamp and move it back over the tube.
→Note Do not loosen the hose clamp to the bottom of the hot water tank
6. Crimp the tube an inch or two away from the drain plug to prevent water from flowing and pull it off the valve.
7. Pull the tube end out of the brewer and position over sink or bucket.
8. Release the crimped tube and hose clamp and allow the water to flow into the sink or container.
9. Reverse steps 4-8 when service is complete. Ensure pinch clamp is open and hose clamps are in place.

Installation safety and hygiene directions-For International and CE equipment

1. Access to the service area is restricted to persons having safety/hygiene knowledge and practical experience of the brewer. This appliance must be installed in locations where it can be overseen by trained personnel.
2. For proper operation, this appliance must be installed indoors where the temperature is between 10°C/50°F to 35°C/95°F. Drain and remove all liquid from equipment and lines if exposed to freezing temperatures.
3. All commercial cooking equipment, including this unit, is not intended for use by children or persons with reduced physical, sensory, or mental capabilities. Ensure proper supervision of children and keep them away from the unit.
4. Children should be supervised to ensure that they do not play hot beverage equipment.
5. This unit must be installed and serviced by qualified personnel only.
6. Installation must conform to all local electrical and plumbing codes. Installation by unqualified personnel will void the unit warranty and may lead to electric shock or burn, as well as damage to unit and/or its surroundings.
7. If the power cord requires repair or replacement-it must be performed by the manufacturer or authorized service personnel with the specified cord only from the manufacturer in order to avoid a hazard.
8. Review the dimensions for the unit and verify that it will fit properly in the space intended for it. Verify that the counter or table will support the total weight of the brewer and dispensers when filled (See: Technical Data).
9. Place the brewer on the counter or stand. When the brewer is in position, level it front to back as well as side-to-side by adjusting the legs.
10. Brewers will need a sturdy supported surface for operation. Do not move brewers when filled.
11. Do not tilt appliance more than 10° to insure safe operation.
12. Unit is for protected indoor use only. Do not steam clean or use excessive water on unit.
13. This unit is not "jet-proof" construction. Do not pressure wash or use jet spray to clean this unit.
14. The unit is not waterproof-do not submerge or saturate with water.

**Equipment exposed to flood and contaminated must not be used due to electrical and food safety.
Do not operate if unit has been submerged or saturated with water.**

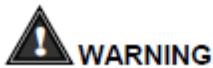

All electrical connections must be in accordance with local electrical codes and any other applicable codes. If the supply cord is damaged, it must be replaced by the manufacturer, its service agent, or similarly qualified persons in order to avoid a hazard.

To prevent an electric shock hazard this device must be bonded to equipment in close proximity with an equipotential bonding conductor. This device is equipped with a bonding lug for this purpose and is marked with the following symbol



	WARNING	To reduce risk of electric shock or fire.
	FETCO® Hot Beverage Equipment is for commercial use only.	
	Do not remove or open cover. No user serviceable parts inside. Refer installation and service to qualified personnel.	
	Caution, disconnect from power supply before servicing.	
	GROUND: National Electrical Code requires separate grounding wire.	
	Use dedicated circuit with capacity rated by local code or National Electrical Code for the current draw of this equipment. Check serial number plate on right side for power requirements.	
	Locate unit away from source of heat. Do not install or use near combustibles.	
	THIS APPLIANCE IS ENERGIZED WHENEVER IT IS CONNECTED TO A POWER SOURCE	
	FAILURE TO COMPLY RISKS EQUIPMENT DAMAGE, PROPERTY DAMAGE, FIRE, OR SHOCK HAZARD	
Notice	This equipment must be installed with a backflow protection device to comply with federal, state or local municipality codes.	
Notice	Read the user guide before installing and operating this unit.	

Labels and warnings for hot beverage equipment

For BACK PANEL of equipment (1046.00035.00)

WIRING METHODS: REFERENCE ONLY: SEE THE WIRING DIAGRAM AT BACK OF THIS GUIDE

TBS-1221/1222 120-volt models with cord and plug

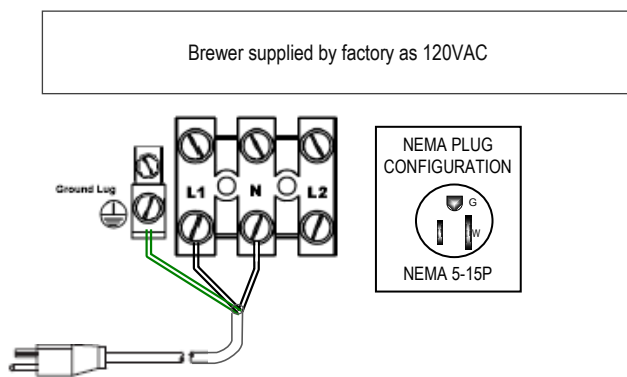

TBS-1221/1222 models 200-240 volt L1, L2,G

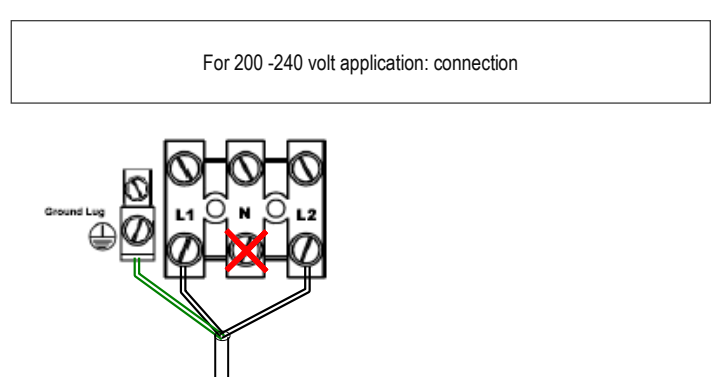

Electrical installation and service is to be made only by licensed electrician.
Disconnect equipment from power supply before service. Equipment may be powered even if power switch is "OFF"

Parts Diagrams

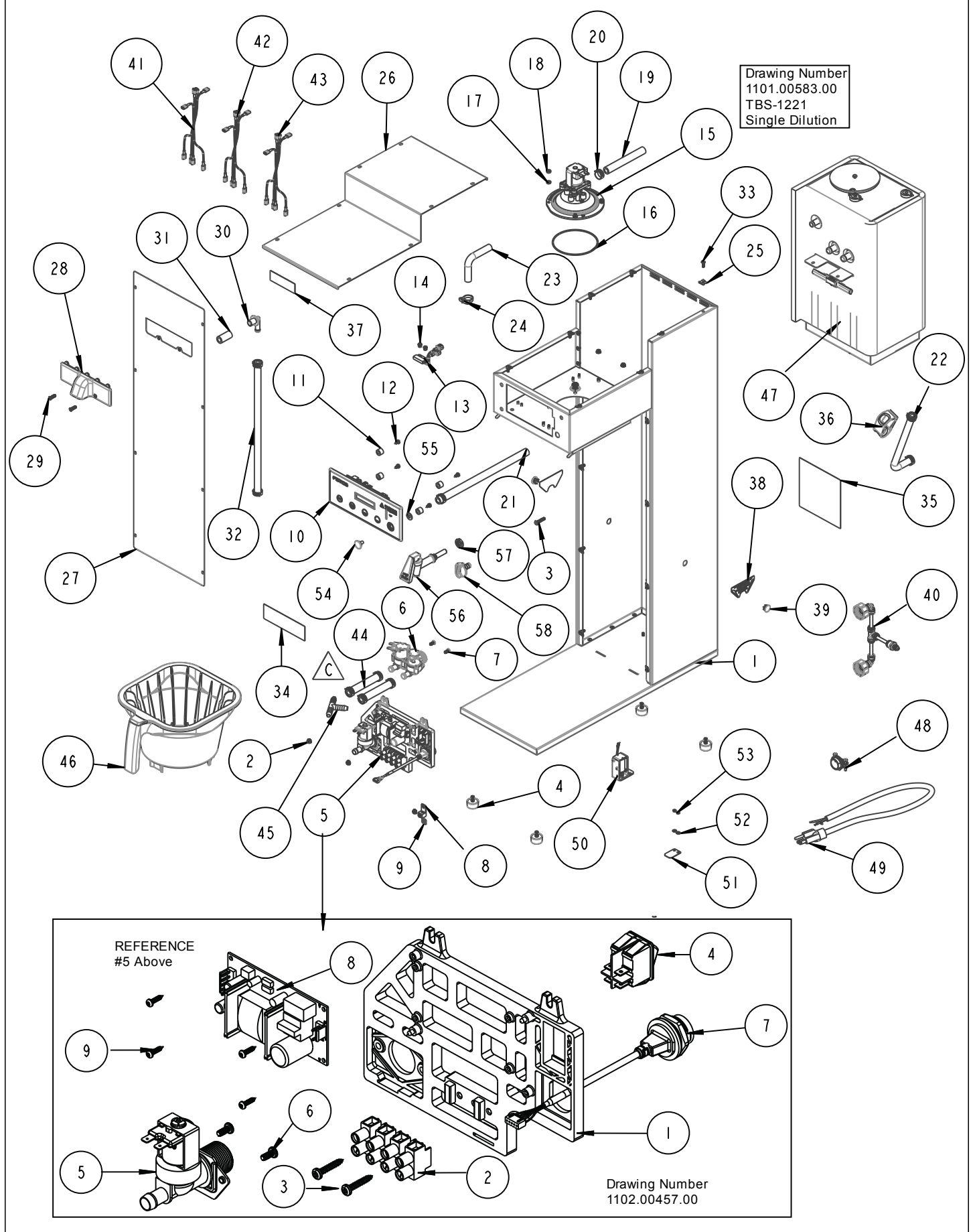

ITEM	Qty	PART NO	DESCRIPTION	TBS-1221 SINGLE Drawing number 1101.00583.00
1	1	1111.00111.00	WELDMENT BODY, TBS-1200	
2	7	1084.00051.00	NUT, HEX LOCKWASHER, #8-32, 18-8 ST. STL	
3	1	1082.00082.00	SCREW, PHILLIP HD., 8-32 THREAD	
4	4	1073.00021.00	FOOT, RUBBER, 1/4-20	
5 REF	1	Reference	ELECTRICAL COMPONENT LATTICE, CBS-1200 [P/N 1102.00457.00]	
5-1	1	1023.00360.00	ELECTRICAL MOUNTING LATTICE, AIR POT	
5-2	1	1052.00023.00	EUROSTRIP HE16 TERM. BLOCK, 4 POLE, 63 AMP, 18-8 AWG	
5-3	2	1082.00056.00	SCREW, #8-11 X 1" PAN HD PHIL, THREAD FORMING	
5-4	1	1058.00024.00	SWITCH, POWER, DOUBLE POLE, 16A, 125/250 VAC	
5-5	1	1057.00043.00	SOLENOID VALVE, 5.5L/min, 180 DEG, 24VDC	
5-6	2	1082.00010.00	SCREW, PAN HD. PHIL. MACH., M4x10 ZINC-PLATED	
5-7	1	1058.00055.00	USB CONNECTOR	
5-8	1	1052.00001.00	POWER SUPPLY, 90-264VAC/24VDC, 1.8A	
5-9	4	1082.00132.00	SCREW, PAN HD. PHIL. THREAD-FORMING, #4-20x5/16"LG.	
6	1	1057.00079.00	FILL VALVE, DOUBLE, 180 DEG, 24VDC, (2.1-2.5L/min INLET FLOW)	
7	2	1082.00010.00	SCREW, PAN HD. PHIL. MACH., M4x10 ZINC-PLATED	
8	1	1065.00009.00	GROUND LUG CONNECTOR, 14-2 AWG, ALUMINUM	
9	1	1044.00012.00	LABEL GROUND, CE	
10	1	1102.00453.00	ASSEMBLY, FRONT PANEL, CBS-1220	
11	4	1023.00361.00	SPACER, UNTHREADED, 1/2"OD X 3/8" LONG	
12	4	1082.00115.00	SCREW, #6 x 3/8" LG., SLOTTED HEX HD. WASHER	
13	1	1102.00113.00	SWITCH, REED, ASSEMBLY	
14	2	1029.00006.00	NUT, FINGER KNURLED, #4-40	
15	1	1102.00203.01	ASSEMBLY, SPRAY HOUSING, DSVP11 DESIGN, NO VENT	
16	1	1024.00063.00	O-RING, 3 15/16" x 3/32" CS, DASH # 154, BUNA-N, DURO-A50	
17	4	1083.00010.00	WASHER, #10 SCREW W/NEOPRENE-BONDED SEAL	
18	4	1084.00006.00	NUT, 8-32 18-8 HEX MACHINE SCREW	
19	1	1025.00013.00	TUBE, 5/8"OD X 3/8"ID X 4.5"LG	
20	10	1086.00003.00	UNICLAMP, 15.9 HOSE OD CLAMP	
21	1	1025.00110.00	TUBE DRAIN, 5/8"OD X 3/8"ID X 10" LG.	
22	1	1025.00058.00	TUBE, 9/16"OD X 5/16"ID X 25.00"LG	
23	1	1025.00061.00	TUBE, 9/16"OD X 5/16"ID X 2.75"LG	
24	1	1086.00002.00	CLAMP, HOSE, SIZE "G" NYLON	
25	16	1084.00011.00	NUT, CLIP ON (J-NUT), #6-32, 22-20 GA., BLK-PH FINISH	
26	1	1001.00455.00	TOP COVER, MBS/TBS-1200, LARGE	
27	1	1112.00548.00	WELDMENT FRONT COVER, MBS-1221	
28	1	1023.00397.00	FAUCET, DILUTION, SINGLE, BLACK	
29	2	1082.00058.00	SCREW, # 8-32 X 5/8, FLAT HD, PH, 18-8 SS	
30	1	1023.00183.00	FITTING, ELBOW, GROMMET, .375"	
31	1	1025.00022.00	TUBE, 5/8"OD X 3/8"ID X 1.25LG., BY-PASS	
32	1	1025.00068.00	TUBE, 9/16"OD X 5/16"ID X 21.75"LG	
33	16	1082.00017.00	SCREW, TRUSS HD. PHIL. MACHINE, # 6-32 X 1/2 LG	
34	1	1046.00003.00	LABEL, CSD WARNING, 1.5" X 5.0"	
35	1	1046.00035.00	LABEL, WARNING "TO REDUCE RISK OF ELECTRIC SHOCK OR FIRE"	
36	1	1086.00009.00	CLAMP, 3/4" MAX TUBE OD FLOW CONTROL	
37	1	1041.00034.00	GREEN TEAVARIS PLUS LABEL, LASER ENGRAVED	
38	2	1046.00006.00	LABEL, WARNING, "HOT WATER FAUCET"	
39	2	1086.00047.00	CAP PLUG, PANEL, 15/32 ID x 5/8 OD, TBS-2111	
40	1	1102.00488.00	ASSEMBLY, DUAL WATER INLET CONNECTOR	
41	1	1402.00113.00	WIRE HARNESS ADDITION, POWER SUPPLY GROUND	
42	1	1402.00118.00	WIRE HARNESS, MBS-1221, HIGH AMP	
43	1	1402.00119.00	WIRE HARNESS, MBS-1221, LOW AMP	
44	2	1025.00076.00	TUBE, 5/8 OD x 3/8 ID x 3.75 LG.	
45	1	1029.00002.00	FITTING, HOSE BARB TEE, SIZE 3/8"	
46	1	B020000G2BK	BREW BASKET ASSY, BLACK, TBS, GREEN HANDLE PLUG	
47	1	1104.00204.00	TANK ASSEMBLY, CBS/MBS-1221/TBS, 1.7kW/120VAC	
47	1	1104.00203.00	TANK ASSEMBLY, TBS/CBS/MBS-1221, 3.2kW/240VAC	
48	1	1086.00008.00	CONNECTOR, CLAMP, NON-METALLIC CABLE, 3/4"	
49	1	1063.00016.00	POWER CORD, 120VAC W/NEMA 5-15P PLUG	
49	1	1063.00030.00	CORD PWR, 16A/250VAC, EU1-16P PLUG, W/O CONNECTORS, CE (EXPORT)	
50	1	1102.00219.00	ASSEMBLY, BB LOCKER, 24VDC	
51	1	1003.00259.00	BRACKET, BREW BASKET LOCK COVER	
52	2	1083.00011.00	WASHER, #8 SCREW SIZE, INTERNAL TOOTH LOCK	
53	2	1084.00010.00	NUT, HEX, #6-32, UNDERSIZED, ZINC PLATED	
54	1	1023.00399.00	HOT WATER PLUG & CONNECTOR	
55	1	1083.00023.00	WASHER, 1/4" SCREW SIZE, FLAT	
56	1	1071.00055.00	FAUCET, HOT WATER, PSC-BR-8, WITH FLAT AND STEM	
57	1	1084.00048.00	JAM NUT, 1/2-20 UNF, NICKEL PLATED BRASS	
58	1	1023.00147.00	PLUG, TANK SERVICE DRAIN FOR 18 GA AND UP BODY	

Drawing Number
1101.00584.00
TBS-1222
Dual Dilution

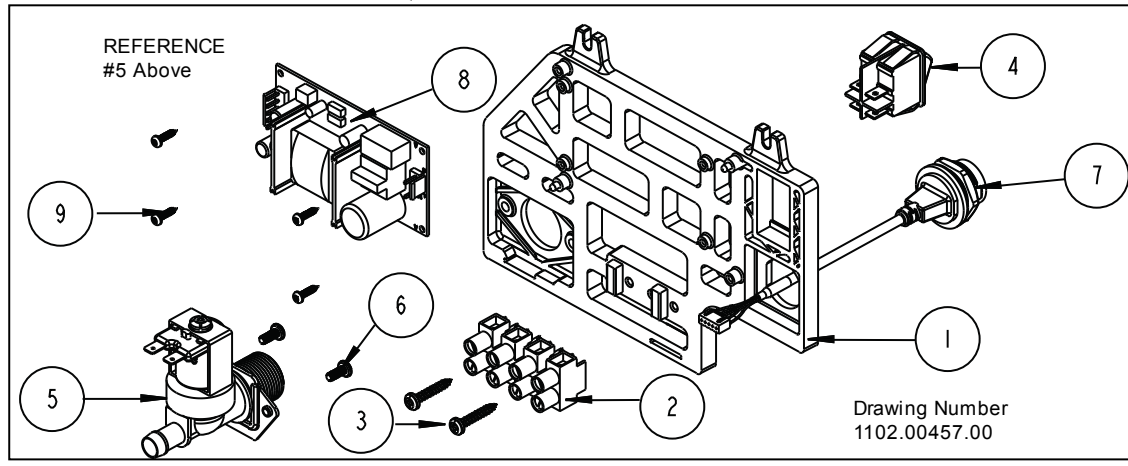
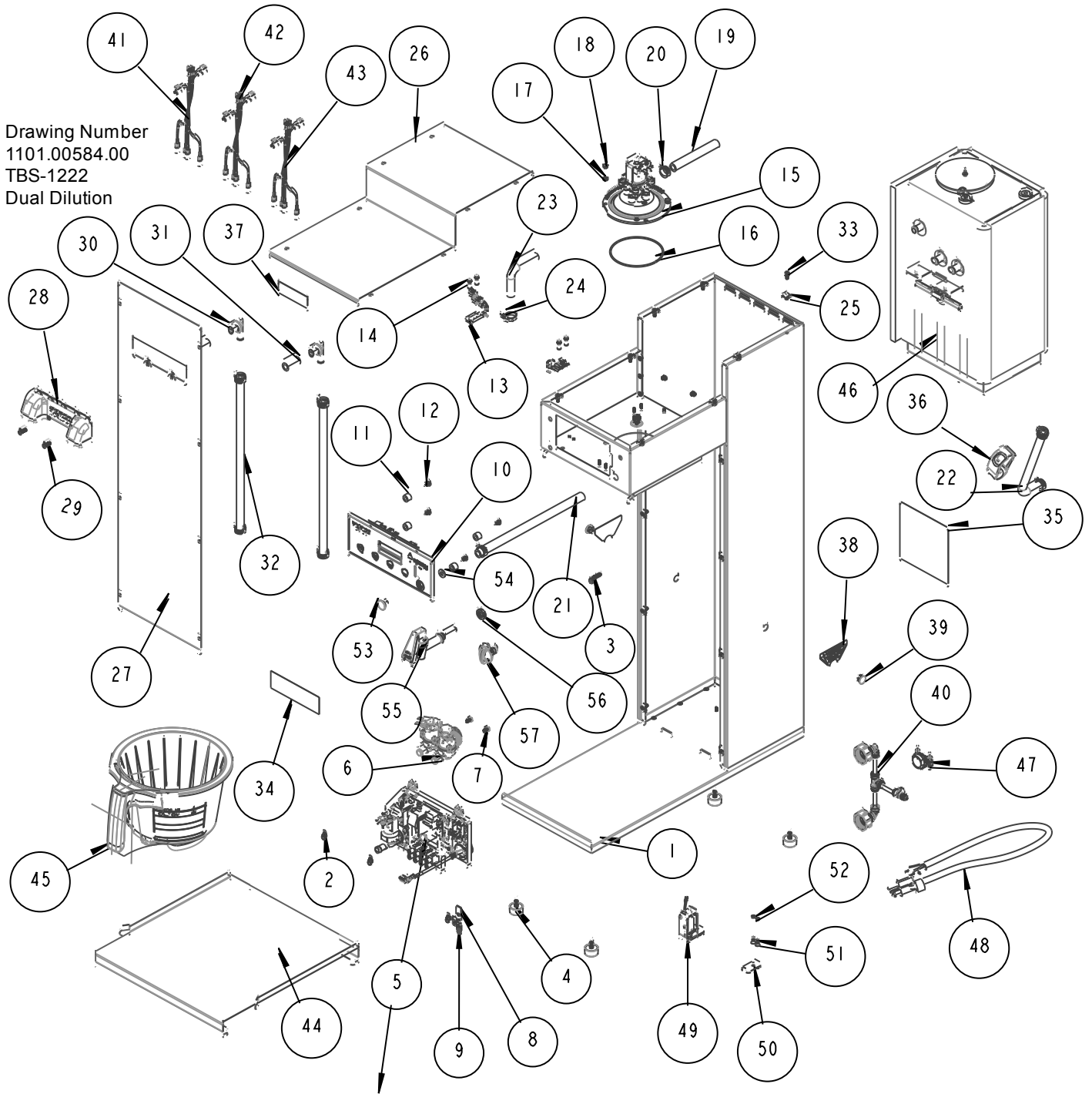

ITEM	Qty	PART NO	DESCRIPTION	TBS-1222 DUAL Dilution Drawing number 1101.00584.00
1	1	1111.00111.00	WELDMENT BODY, TBS-1200	
2	7	1084.00051.00	NUT, HEX LOCKWASHER, #8-32, 18-8 ST. STL.	
3	1	1082.00082.00	SCREW, PHILLIP HD., 8-32 THREAD	
4	4	1073.00021.00	FOOT, RUBBER, 1/4-20	
5 REF	1	Reference	ELECTRICAL COMPONENT LATTICE, CBS-1200 [P/N 1102.00457.00]	
5-1	1	1023.00360.00	ELECTRICAL MOUNTING LATTICE, AIR POT	
5-2	1	1052.00023.00	EUROSTRIP HE16 TERM. BLOCK, 4 POLE, 63 AMP, 18-8 AWG	
5-3	2	1082.00056.00	SCREW, #8-11 X 1" PAN HD PHIL, THREAD FORMING	
5-4	1	1058.00024.00	SWITCH, POWER, DOUBLE POLE, 16A, 125/250 VAC	
5-5	1	1057.00043.00	SOLENOID VALVE, 5.5L/min, 180 DEG, 24VDC	
5-6	2	1082.00010.00	SCREW, PAN HD. PHIL. MACH., M4x10 ZINC-PLATED	
5-7	1	1058.00055.00	USB CONNECTOR	
5-8	1	1052.00001.00	POWER SUPPLY, 90-264VAC/24VDC, 1.8A	
5-9	4	1082.00132.00	SCREW, PAN HD. PHIL. THREAD-FORMING, #4-20x5/16"LG.	
6	1	1057.00079.00	FILL VALVE, DOUBLE, 180 DEG, 24VDC, (2.1-2.5L/min INLET FLOW)	
7	2	1082.00010.00	SCREW, PAN HD. PHIL. MACH., M4x10 ZINC-PLATED	
8	1	1065.00009.00	GROUND LUG CONNECTOR, 14-2 AWG, ALUMINUM	
9	1	1044.00012.00	LABEL GROUND, CE	
10	1	1102.00453.00	ASSEMBLY, FRONT PANEL, CBS-1220	
11	4	1023.00361.00	SPACER, UNTHREADED, 1/2"OD X 3/8" LONG	
12	4	1082.00115.00	SCREW, #6 x 3/8" LG., SLOTTED HEX HD. WASHER	
13	2	1102.00113.00	SWITCH, REED, ASSEMBLY	
14	4	1029.00006.00	NUT, FINGER KNURLED, #4-40	
15	1	1102.00203.01	ASSEMBLY, SPRAY HOUSING, DSVP11 DESIGN, NO VENT	
16	1	1024.00063.00	O-RING, 3 15/16" x 3/32" CS, DASH # 154, BUNA-N, DURO-A50	
17	4	1083.00010.00	WASHER, #10 SCREW W/NEOPRENE-BONDED SEAL	
18	4	1084.00006.00	NUT, 8-32 18-8 HEX MACHINE SCREW	
19	1	1025.00013.00	TUBE, 5/8"OD X 3/8"ID X 4.5"LG	
20	8	1086.00003.00	UNICLAMP, 15.9 HOSE OD CLAMP	
21	1	1025.00110.00	TUBE DRAIN, 5/8"OD X 3/8"ID X 10" LG.	
22	1	1025.00058.00	TUBE, 9/16"OD X 5/16"ID X 25.00"LG	
23	1	1025.00061.00	TUBE, 9/16"OD X 5/16"ID X 2.75"LG	
24	1	1086.00002.00	CLAMP, HOSE, SIZE "G" NYLON	
25	16	1084.00011.00	NUT, CLIP ON (J-NUT), #6-32, 22-20 GA., BLK-PH FINISH	
26	1	1001.00455.00	TOP COVER, MBS/TBS-1200, LARGE	
27	1	1112.00548.00	WELDMENT FRONT COVER, MBS-1221	
28	1	1023.00402.00	FAUCET, DUAL DILUTION, TBS, BLACK	
29	2	1082.00058.00	SCREW, # 8-32 X 5/8, FLAT HD, PH, 18-8 SS	
30	2	1023.00183.00	FITTING, ELBOW, GROMMET, .375"	
31	2	1025.00022.00	TUBE, 5/8"OD X 3/8"ID X 1.25LG., BY-PASS	
32	2	1025.00068.00	TUBE, 9/16"OD X 5/16"ID X 21.75"LG	
33	16	1082.00017.00	SCREW, TRUSS HD. PHIL. MACHINE, # 6-32 X 1/2 LG.	
34	1	1046.00003.00	LABEL, CSD WARNING, 1.5" X 5.0"	
35	1	1046.00035.00	LABEL, WARNING "TO REDUCE RISK OF ELECTRIC SHOCK OR FIRE"	
36	1	1086.00009.00	CLAMP, 3/4" MAX TUBE OD FLOW CONTROL	
37	1	1041.00034.00	GREEN TEAVARIS PLUS LABEL, LASER ENGRAVED	
38	2	1046.00006.00	LABEL, WARNING, "HOT WATER FAUCET"	
39	2	1086.00047.00	CAP PLUG, PANEL, 15/32 ID x 5/8 OD, TBS-2111	
40	1	1102.00488.00	ASSEMBLY, DUAL WATER INLET CONNECTOR	
41	1	1402.00113.00	WIRE HARNESS ADDITION, POWER SUPPLY GROUND	
42	1	1402.00118.00	WIRE HARNESS, MBS-1221, HIGH AMP	
43	1	1402.00119.00	WIRE HARNESS, MBS-1221, LOW AMP	
44	1	1001.00456.00	BASE, DOUBLE, TBS-1222	
45	1	B013000G2BK	BREW BASKET ASSY, BLACK, DUAL TEA, GREEN HANDLE PLUG	
46	1	1104.00204.00	TANK ASSEMBLY, CBS/MBS-1221, 1.7kW/120VAC	
47	1	1086.00008.00	CONNECTOR, CLAMP, NON-METALLIC CABLE, 3/4"	
48	1	1063.00016.00	POWER CORD, 120VAC W/NEMA 5-15P PLUG	
49	1	1102.00219.00	ASSEMBLY, BB LOCKER, 24VDC	
50	1	1003.00259.00	BRACKET, BREW BASKET LOCK COVER	
51	2	1083.00011.00	WASHER, #8 SCREW SIZE, INTERNAL TOOTH LOCK	
52	2	1084.00010.00	NUT, HEX, #6-32, UNDERSIZED, ZINC PLATED	
53	1	1023.00399.00	HOT WATER PLUG & CONNECTOR	
54	1	1083.00023.00	WASHER, 1/4" SCREW SIZE, FLAT	
55	1	1071.00055.00	FAUCET, HOT WATER, PSC-BR-8, WITH FLAT AND STEM	
56	1	1084.00048.00	JAM NUT, 1/2-20 UNF, NICKEL PLATED BRASS	
57	1	1023.00147.00	PLUG, TANK SERVICE DRAIN FOR 18 GA AND UP BODY	

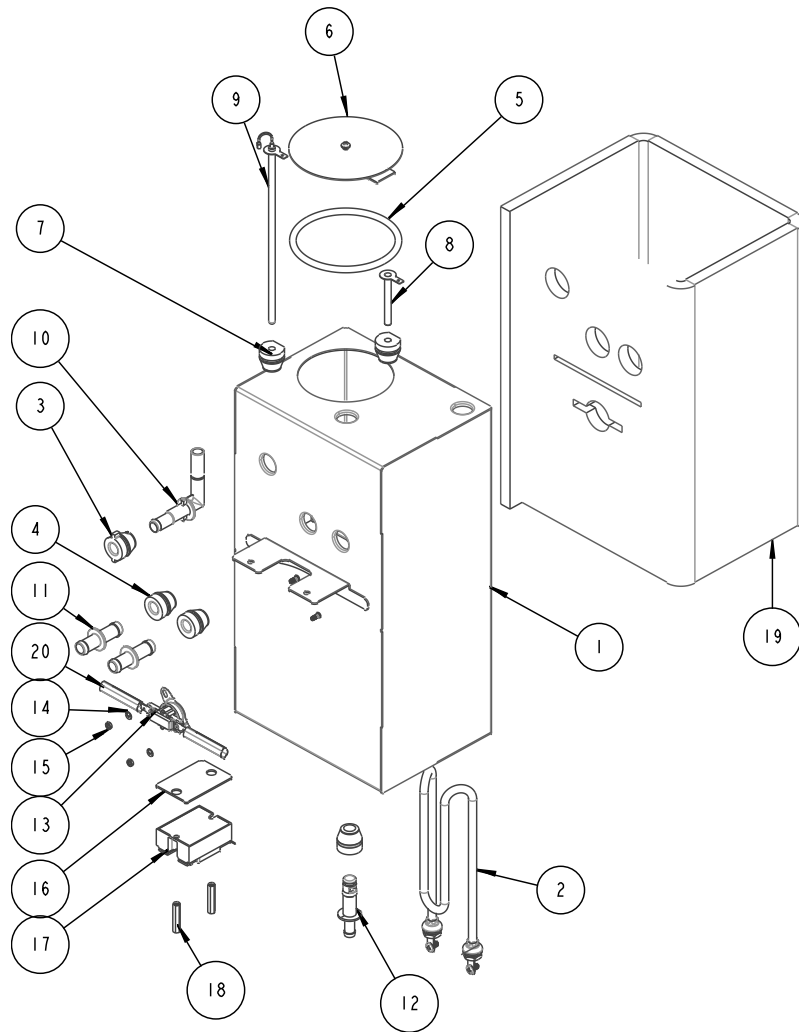

ITEM	Qty	PART NO	DESCRIPTION
			Hot water tank drawing numbers 1104.00203.00 & 1104.00204.00
1	1	1114.00173.00	WELDMENT, TANK, CBS/MBS-1221, ONE HEATER
2	1	1107.00002.00	HEATER ASSY, IMMERSION 3000W/240VAC
2	1	1107.00003.00	HEATER ASSY, IMMERSION 1700W/120VAC
3	1	1024.00111.00	GROMMET, SILICONE, W/ POSITION TABS
4	3	1024.00050.00	GROMMET, SILICONE, 11.4mm ID
5	1	1024.00007.00	O-RING, DASH #344, TANK COVER
6	1	1102.00207.00	TANK COVER ASSEMBLY, TBS-2121
7	2	1024.00062.00	GROMMET, SHORT, SILICONE, LEVEL AND TEMP PROBE
8	1	1112.00002.00	PROBE WELDMENT, WATER LEVEL 2.25" LG
9	1	1102.00161.00	PROBE ASSEMBLY, TEMP. AND LLC, 8" LONG
10	1	1023.00362.00	FITTING VENT, ELBOW, .375" X .375", SELF POSITIONING
11	2	1023.00167.00	FITTING, STRAIGHT, GROMMET, .500"
12	1	1023.00166.00	FITTING, COLD WATER INLET, GROMMET DESIGN
13	1	1053.00051.00	THERMOSTAT, SINGLE SHOT, 240V/25A
14	2	1083.00009.00	WASHER, #6 SCREW, INTL TOOTH LOCKWASHER
15	2	1084.00010.00	NUT, HEX, #6-32, UNDERSIZED, ZINC PLATED
16	1	1003.00140.00	ALUMINUM BRACKET FOR SSR
17	1	1052.00033.00	RELAY, SOLID STATE, 50A/480VAC, W/BUILD IN VARISTOR
18	2	1081.00042.00	STANDOFF, 1/4" HEX
19	1	1022.00112.00	TANK INSULATION, CBS-1221
20	2	1022.00032.00	SLEEVE, Ø.50 x 2.0" LG. x 1.50" SLOT

Small Spray Head Assembly CBS-1221 Part #16 pages 15-16 (Check your equipment to determine your type)

FETCO 24 volt small spray dome is found on some models of CBS-1200, MBS-1200, TBS-1200 all models
CBS-1131V+, CBS-1132V+
CBS-1141V+, CBS-1142V+

Small spray dome parts breakdown

Part #1000.0097.00
Complete, assembled
24 volt valve kit
with o-ring

Part #1000.0098.00
Valve rebuild kit contains
spring, plunger and diaphragm.

Part # 1102-00203.01
Complete 24-volt spray housing
factory assembled

Part #1000.00142.00
Small spray housing kit with o-ring
and cascading spray dome

1102.00019.00 Small
cascading spray dome, red

1024.00063.00 Spray housing
O-RING, 3 15/16" x 3/32"
CS, DASH # 154, DURO-A50

Small Spray Assembly Parts List-alternate version (Check your equipment to determine your type)

Part # 1102.00456.00
Quick connect sprayhead
CBS-1200 Series

ITEM	Qty	PART NO	DESCRIPTION	Drawing number 1101.00569.00
1	1	1000.00142.00	BASE, QUICK CONNECT SPRAY HEAD, RETROFIT	
2	1	1102.00479.00	ASSEMBLY, CASCADE SPRAY DOME, NEXT GEN, ORANGE	
3	1	1023.00342.00	QUICK CONNECT CLIP	
4	1	1057.00076.00	VALVE ASSEMBLY, COMPLETE, NG, DELTROL(interchangeable with 1057.00078.00)	
4	1	1057.00078.00	VALVE ASSEMBLY, COMPLETE, NG, RPE (interchangeable with 1057.00076.00)	
5	1	1024.00063.00	O-RING, 3 15/16" x 3/32" CS, DASH # 154, BUNA-N, DURO-A50	
NS	4	1083.00010.00	WASHER, #10 SCREW W/NEOPRENE-BONDED SEAL	
NS	4	1084.00006.00	NUT, 8-32 18-8 HEX MACHINE SCREW	

Brew Baskets Parts Lists

Brewer systems have two brew basket types:

Square type for TBS-1221 Single brewer

Round type for TBS-1222 Dual brewer

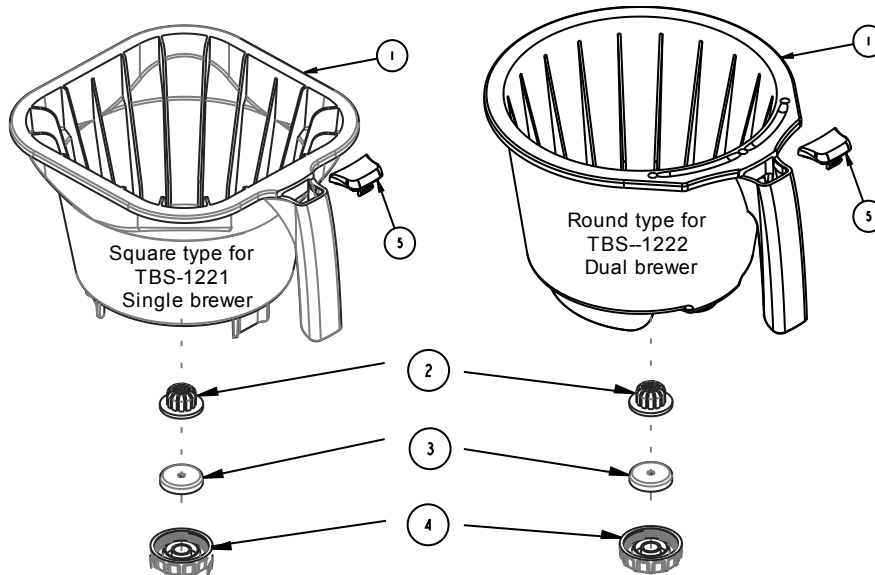

Ref#	Qty	Part Number	Description
1	1	1023.00289.00	BREW BASKET, 16" X 6"SQUARE-SINGLE BREWER ONLY
1	1	1023.00182.00	BREW BASKET, ROUND-DUAL BREWER ONLY
2	1	1024.00060.00	STRAINER, SILICONE
3*	1	1023.00185.00	ORIFICE, SET OF 9 SEE BELOW*
4	1	1023.00179.00	NUT, BREW BASKET ORIFICE HOLDER
5	1	1023.00191.00	PLUG, BB HANDLE, GREEN
NS	1	B020000G2BK	Complete SQUARE Brew basket TBS-1221 t→For SINGLE brewer only
NS	1	B013000G2BK	Complete ROUND Brew basket TBS-1222 →For DUAL brewer only

* Reference #3 orifice set size

0.062	24:30 minutes: seconds
0.078	17:30 minutes: seconds
0.086	15:30 minutes: seconds
0.094	11:30 minutes: seconds
0.104	10:30 minutes: seconds
0.104 is DEFAULT-and is factory installed on brew basket	
0.125	8:10 minutes: seconds
0.140	6:10 minutes: seconds
0.180	3:50 minutes: seconds
0.280	1:20 minutes: seconds

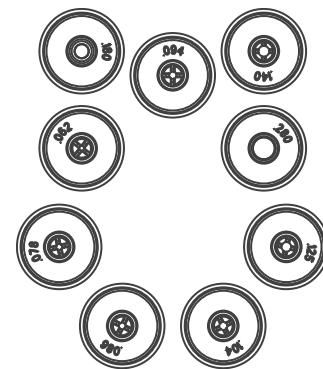

Orifice inserts for brew basket
0.104 is factory installed

Wiring Diagram

FOR SKU
 T1221US-1A117-PM001, T122DUS-1A117-PN00
 T1221IN-1B130-PN005, T122DIN-1B130-PN005

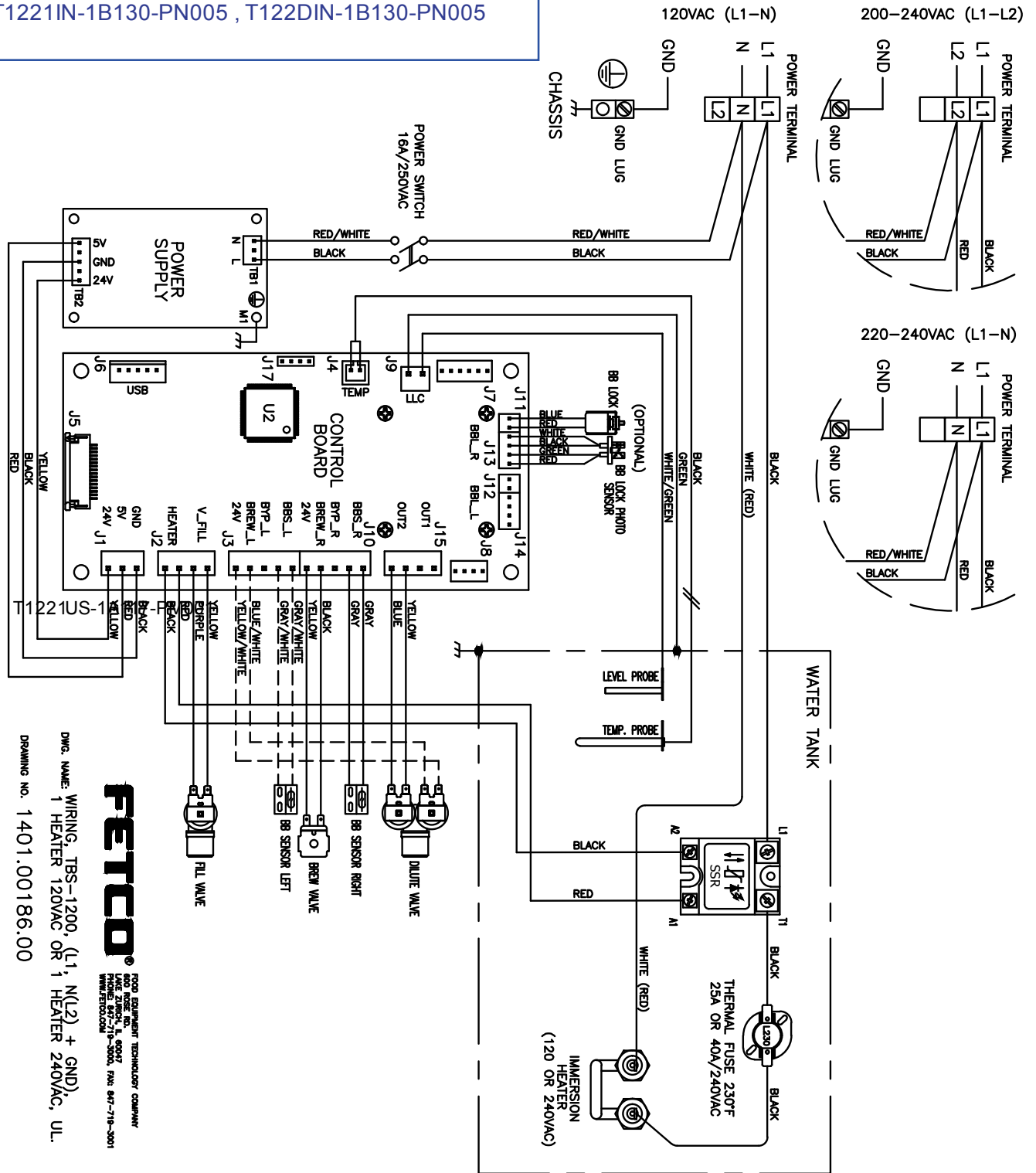

DWG. NAME: WIRING, TBS-1200, (L1, N(L2) + GND), UL.
 DRAWING NO. 1401.00186.00

PETCO

FROM EQUIPMENT TECHNOLOGY COMPANY
 600 ROSE RD.
 LAKE ZURICH, IL 60047
 WWW.PETCO.COM
 WWW.ETC.COM



THE URNEX SYSTEM M™

BEHIND EVERY GREAT CUP

TABZ™ TEA CLEAN™ TABLETS

Tea Brewer Cleaner

- Cleans brew basket and serving vessel in one simple step.
- Specially formulated for the removal of tea stains from tea brewers.
- Regular cleaning ensures fresh tasting brewed tea and properly maintained brewing equipment.
- Tablet form for easy and controlled dosing helps reduce waste and reduce operator error.



Instructions For Use:

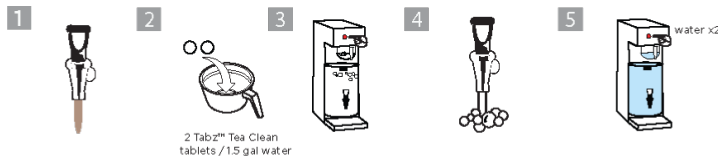

Case and Pallet Information:

UNIT	CASE	PALLET
Code: 15-T61-UX120 Inner UPC: 7546316037 57 Contents: 120 tblt jar (4.0 g x 20 mm) Per case: 12 jars	Code: 15-T61-UX120-12 Barcode: 107546316 03754 Inches (Lx W x H): 11.25 x 8.50 x 8.50 Centimeters: 28.6 x 21.6 x 21.6 Weight: 14.6 lbs (6.6 kg)	Per Pallet: 102 cases Layout: 6 layers of 17 cases Weight: 1,525 lbs (692 kg) Height: 57 in. (1.45 m)

Urnex Brands, LLC
700 Executive Blvd | Elmsford, NY 10523 USA
Tel: +1-914-963-2042 Fax: +1-914-963-2145
info@urnex.com | www.urnex.com



NSF Protocol for Health Effects and Corrosivity of Commercial Espresso Machine Chemical Cleaners (2018)



URNEX® CARE CATEGORY
TEA

