

$\int_f^t$  Touch Function Selector Technology

## HWD-2110 Hot Water Dispenser



**NOTICE TO INSTALLER: Please leave this book with the machine.**



Temperature On Demand US design patent applied for. Other Temperature On Demand US patents applied for.  
FETCO® is a trademark of Food Equipment Technologies Company.

# FETCO® Hot Water Dispenser

## Contact Information

**FETCO®**  
 Food Equipment Technologies Company  
 600 Rose Road  
 Lake Zurich • IL • 60047-0429 • USA

**Phone:** (800) 338-2699 (US & Canada)  
 (847) 719-3000  
**Fax:** (847) 719-3001

**Email:** sales@fetco.com  
 techsupport@fetco.com

**Internet:** www.fetco.com

## Description & Features

Water temperature selectable to 158°-204°F/70-96°C English and Metric temperature ranges selectable  
 Maximum single dispense is 24ounces/700cc in 15 seconds maximum dispense time  
 Non-Temperature on Demand and Temperature on Demand (TOD) configurations is available as separate equipment.

## Specifications

Electrical Configurations-DOMESTIC								
Configuration Code	Heater Configuration	Voltage	Phase	Wires	Electrical Connection	KW	Maximum Amp Draw	Gallons/Hour
H211011	1 X 5 kW	200-240	1	2+G	NEMA 6-30P plug	3.6-5.1	17.4-21	9.5-13.5gallon*/36-51 liter
Electrical Configurations-EXPORT & CANADA								
H211021	1 X 5 kW	200-240	1	2+G	Cord Only†	3.6-5.1	17.4-21	9.5-13.5gallon*/36-51 liter
*NOTE: Temperature ranges selectable from 158°-204°F/70-96°C based on 207°F/97°C hot water tank temperature.						† For EXPORT, Cord without plug will be attached		
Temperature of dispensed hot water may vary up to 3 ½ % of displayed temperature selection.								
*Flow rate per hour based on 65-70°F/18-21°C mains water supply temperature at lowest possible electrical supply current								
*Factors affecting temperature accuracy include quantity of hot water dispensed, ambient air temperature, distance of container from hot water faucet (pouring over longer distance causes more cooling)								

**Pressure: 40-75 psig, (276-517kPa)**

**Water Requirements: Minimum Flow Rate: 1½gpm (5.7lpm)**

**Water connection inlet: ¼ inch male flare fitting.**

### Power Plug Configurations

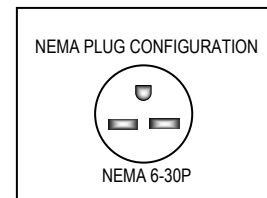

## Weights and Capacities

Dispenser Model	Height	Width	Depth	Water tank capacity	Empty Weight	Filled Weight	Shipping Weight
HWD-2110	24 1/2 in/62 cm	10 in/25.4 cm	19 1/2 in/49.5 cm	4.6 gallon/17.4 liter	30 lbs/13.6 kg	68.3 lbs/31 kg	44 lbs/20 kg

### NEW TECHNOLOGICAL FEATURES

The FETCO hot water dispenser uses new <sup>t</sup><sub>f</sub> Touch Function Selector Technology to operate the hot water dispenser.  
 The <sup>t</sup><sub>f</sub> Touch Function Selector buttons (above and below display screen) alternately dim and brighten when selection is not active.  
 Dispensing and Feature Selections activate when touched. The front panel is clean and uncluttered.  
 Programming, display and error codes are interactive and more intuitive.  
 Float indicator is built into drip tray to help simplify maintenance and cleaning.

#### NOTE:

The HWD-2110 Digital Hot Water Dispenser cannot be modified into a HWD-2110 TOD Temperature on Demand Hot Water Dispenser

# Dimensions & Utility Connections

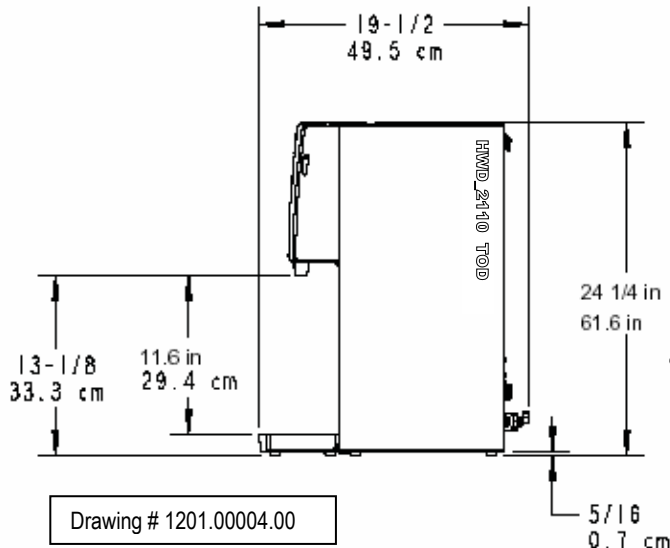

BACK PANEL VIEW FOR UTILITY CONNECTIONS

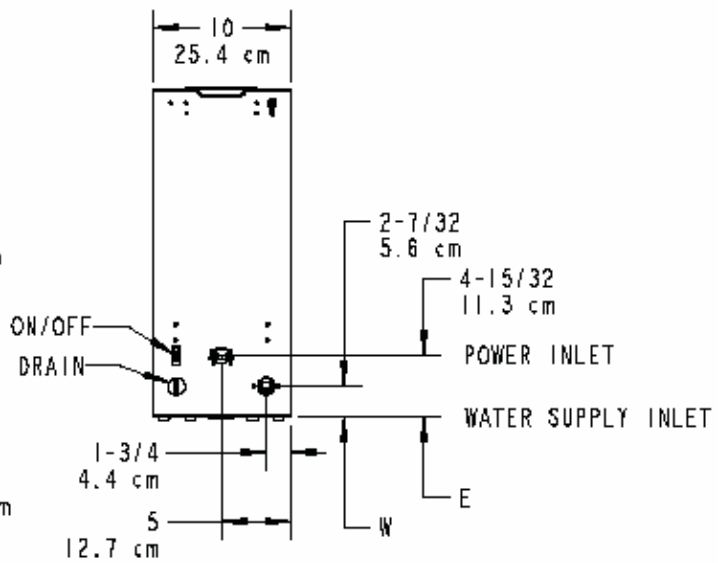

Water inlet fitting: ¼ inch male flare fitting

## Installation

The installation must comply with applicable federal, state, and local codes having jurisdiction at your location. Utilize only qualified beverage equipment service technicians for installation.

A Service Company Directory may be found on our website, <http://www.fetco.com>.

### Setup

1. Before placing the unit, verify that it will fit in the space intended for it, and that the counter or table will support the weight of the HWD-2110 when filled.
2. When the unit is in position, use a bubble level to level it front to back and side to side by adjusting the legs.

### Water Connection

1. Water inlet is a ¼ inch male flare fitting.
2. Install a shut off valve near the unit to facilitate service.
3. Install a backflow prevention device, a spring loaded double check valve such as a WATTS® SD-2 or SD-3, two models accepted by most zoning authorities. The check valve should be as close to the water supply inlet as possible.
4. An inline water filter is highly recommended. It should be installed after the water shutoff valve and in a position to facilitate filter replacement.
5. Flush the water supply line and filter **before** connecting it to the unit.
6. Verify that the water line provides at least 1½ gpm (5.7lpm), and that the water pressure is between 40-75 psig (276-517kPa).

### Electrical Connection

1. Check serial number plate for the maximum wattage and verify that the actual voltage at the electrical outlet is compatible with the unit's specifications.
2. Plug unit in. Note that the plug is NEMA 6-30P, is for 30 amp 240 volt supply.
3. The temperature and water tank fill level are pre-set at the factory and there is no need to turn off the heater during the installation process. The heating process will start automatically when the tank is filled with enough water to safely cover the heating element.

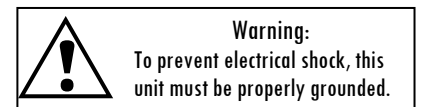
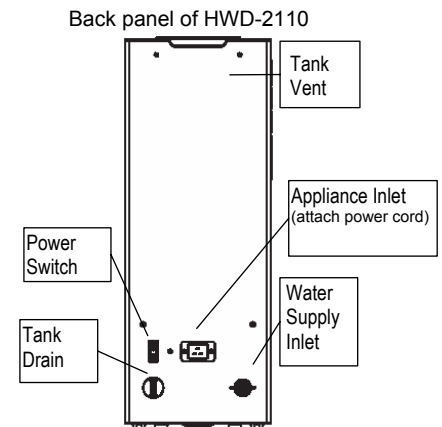
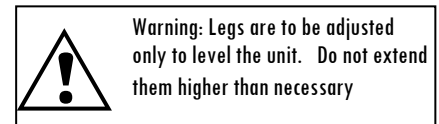

**WARNING**-Do not plug in this equipment or attempt to operate without all covers in place and all screws fastened.

## Final Setup-Fill and Initial Heating

1. Turn on the incoming water supply line and inspect both inside and outside of the unit for leaks in all fittings and tubes.
2. Plug the unit into the appropriate electrical outlet.
3. Turn on the unit's main power switch (located on the back).  
Screen one-the FETCO Home Screen will display.
4. Within 6 seconds, the water tank will begin filling until tank probe senses water  
Screen two, the "FILLING" will display.
5. Water will cover heating element or when tank water is heating from cold,  
Screen three-the "HEATING" Screen will display.  
The upper and lower "Touch Function Selector" will not light.
6. After the water has reached the lowest of the four set temperatures, the lower "Touch Function Selector" will light red color to signal that at least one temperature range is READY  
(The touch selector buttons will alternately dim and brighten when selection is not active)
7. The display will read the four temperature settings as the tank temperature rises. More detailed operation information follows
8. The upper "Touch Function Selector" will light if one or more temperature level is available during heating
9. Re- inspect for leaks.

## Operating Instructions

1. Turn the main power switch on.
2. Touch the upper "Touch Function Selector", tapping finger to scroll to select
3. When a temperature is enlarged and brightened - that temperature is available.  
Touch the lower red selector to dispense hot water.
4. Maximum continuous "ON" is fifteen (15) seconds in a single activating touch
5. Maximum dispense is approximately 22ounces/700cc.  
Approximately three full 15 second batches may be dispensed in succession.
6. Unit returns to inactive "Enabled Screen" if no water is dispensed in 3 seconds
7. Steam and condensation from the water tank is released into the vent whenever the unit is on. Access the vent barbed fitting located on the upper back to run gravity drain. For venting to a drain, tubing requirement is 1/4" I.D. (To prevent vacuum backflow, do not place discharge end of vent drain tube into drain sump)

## Operator Training

Review the operating procedures with everyone who will be using the unit.

Pay particular attention to the following areas:

1. Selecting and dispensing water at all four levels
2. How to change temperature settings (See page 7)
3. Scrolling and selecting temperatures and operating the hot water faucet.

Pay particular attention to the safety warnings. (See page 6 & 7)

4. Refer to cleaning procedures and drip tray, listed on the following page.
5. Show the location of the on/off switch, water shut off valve and the utility power supply circuit breaker for the unit. (See page 3)

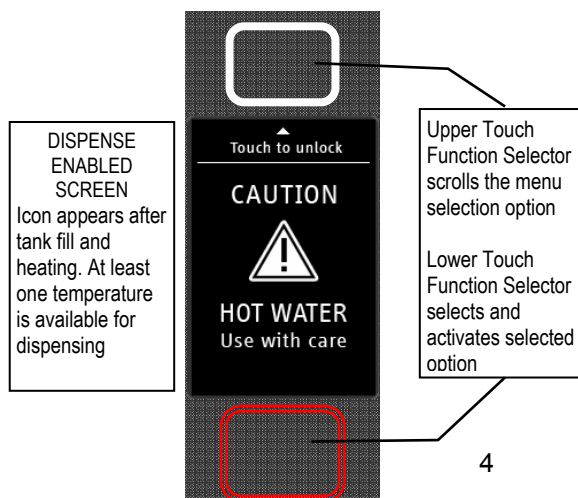

4

## The three primary screens for HWD-2110 start up



Above-Screen One-FETCO Home Screen  
Below-Screen Two-HWD Status Screen

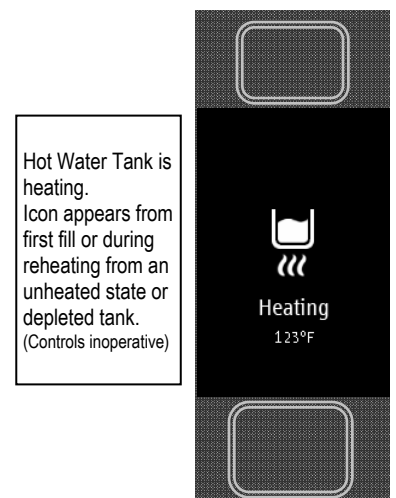
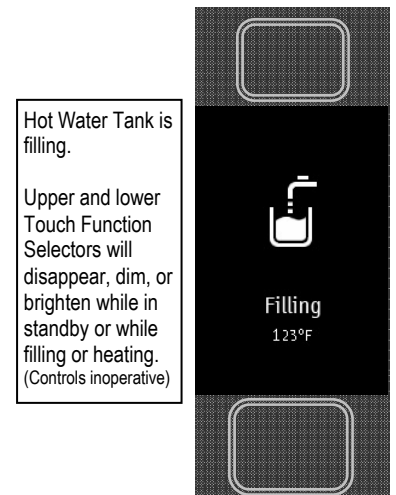

Above-Screen Three-HWD Status Screen

# Operating Principles

The dispense valve assembly mixes very hot tank water with cooler water to deliver precision temperature water at selected temperatures.

When hot water is drawn from the faucet, the fill valve pulses on and off every few seconds to replenish the tank.

By controlling the flow of incoming water, the amount of cold water entering the tank is synchronized with the rate at which the water can be heated. This ensures an uninterrupted supply of hot water.

When dispensing water at a rate that exceeds the unit's capacity to heat, the screen will show that the temperature is not available.

If hot water tank supply is depleted during high use, faucet will temporary "lockout" to allow the hot water tank to reheat for an adequate hot water supply. The "HEATING" screen will display at this time.

## Cleaning & Maintenance

Daily:

- Check the drip tray and empty if necessary. An indicator pop-up center button rises when full.

Quarterly:

- Inspect all fittings and hoses for leaks.
- Inspect inside of tank for lime deposits. De-lime tank and probes if necessary. This procedure should be performed by a qualified service technician

Notice:

- Turn off power to the HWD-2110 before any cleaning procedure, including wiping the exterior for appearance reasons. Dry the exterior, especially the face panel, before turning on power.

### **WARNING:**

- **Do not apply any type of spray cleaner on the face panel of this equipment.**
- **Never use any solvent based cleaner or polish on this equipment.**
- **Dry the face of the HWD-2110 before turning on power.**
- **WARNING-Do not energize this equipment or attempt to operate without all covers in place and all screws fastened.**

## Tank Drain

The water tank must be drained before maintenance procedures, and when the unit is to be relocated or shipped.

1. Disconnect power to the unit.
2. Move the unit near a sink or obtain a container to large enough to hold four gallons of water.
3. Remove the tank cover and allow the tank to cool to a safe temperature.
4. The tank drain is located on the back of the unit. Turn the drain plug one-quarter turn in either direction.
5. Pull the plug out far enough to expose the silicone tube.
6. Using pliers loosen the hose clamp and move it back over the tube.
7. Crimp the tube an inch or two away from the drain plug to prevent water from flowing.
8. Use the other hand to pull the drain plug out of the tube.
9. Release the crimped tube and allow the water to flow into the sink or container.

# Control and Operational Screens

The FETCO® Hot Water Dispenser uses a digital display screen and illuminated touch pads to control the set-up and on-off water functions.

-Upper and lower pads are lighted when ready, and may alternately brighten and dim.

-Touch lower (red) pad to activate.







-“WARNING-HOT WATER” screen will light for two to three (2-3) seconds

-The upper (white) selector pad will light when selected temperature is ready

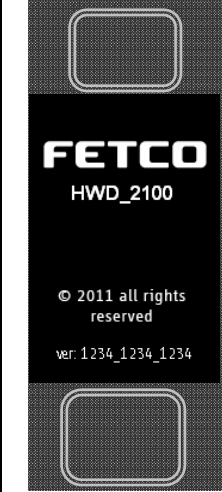
-Touch **and hold** lower (red) pad to dispense hot water.

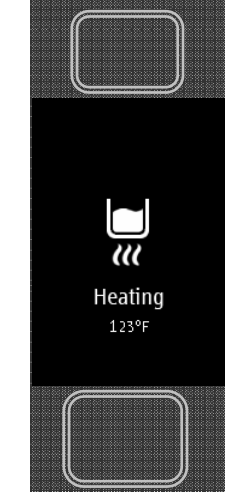
-Maximum single dispense is 24ounces/700cc in 15 seconds maximum dispense time

-When dispensing an amount of water- (“DISPENSE ENABLED SCREEN”) displays after five (3) seconds inactivity.

					
HOME SCREEN	First screen on start-up	HEATING No temperatures ready	DISPENSE ENABLED Touch to go to next screen	Hot water dispense enabled	Fault state, Error. Screen will pulse and lock out dispense

# Programming and diagnostic screens

To enter Programming and Diagnostics dialog screens

Turn power switch on lower back of unit "OFF"

Turn power switch "ON" and when first screen is displayed touch lower (red) pad to activate

The First Programming screen will display. Displayed are the default settings programmed into the equipment

Touch upper "Touch Function Selector" to scroll through the programming lines.

Touch lower (red) pad to scroll through the screens and active outputs.

Setting **as displayed** will be saved on exit.

EXIT Programming and Diagnostics dialog by selecting EXIT and touching the lower (red) pad

				<p><b>Chart to correct for boiling point for altitude in tank water temperature. See INPUT Screen</b></p> <table border="1"> <thead> <tr> <th>Altitude (ft.)</th> <th>Suggested Setting(°F)</th> <th>Boiling point (° F)</th> </tr> </thead> <tbody> <tr><td>-500</td><td>207</td><td>212.9</td></tr> <tr><td>0</td><td>207</td><td>212.0</td></tr> <tr><td>500</td><td>207</td><td>211.1</td></tr> <tr><td>1000</td><td>205</td><td>210.2</td></tr> <tr><td>2000</td><td>204</td><td>208.4</td></tr> <tr><td>2500</td><td>203</td><td>207.5</td></tr> <tr><td>3000</td><td>200</td><td>206.6</td></tr> <tr><td>3500</td><td>197</td><td>205.7</td></tr> <tr><td>4000</td><td>195</td><td>204.8</td></tr> <tr><td>4500</td><td>194</td><td>203.9</td></tr> <tr><td>5000</td><td>194</td><td>203.0</td></tr> <tr><td>5500</td><td>193</td><td>202.0</td></tr> <tr><td>6000</td><td>192</td><td>201.1</td></tr> <tr><td>6500</td><td>191</td><td>200.2</td></tr> <tr><td>7000</td><td>190</td><td>199.3</td></tr> <tr><td>7500</td><td>188</td><td>198.3</td></tr> <tr><td>8000</td><td>187</td><td>197.4</td></tr> </tbody> </table>	Altitude (ft.)	Suggested Setting(°F)	Boiling point (° F)	-500	207	212.9	0	207	212.0	500	207	211.1	1000	205	210.2	2000	204	208.4	2500	203	207.5	3000	200	206.6	3500	197	205.7	4000	195	204.8	4500	194	203.9	5000	194	203.0	5500	193	202.0	6000	192	201.1	6500	191	200.2	7000	190	199.3	7500	188	198.3	8000	187	197.4
Altitude (ft.)	Suggested Setting(°F)	Boiling point (° F)																																																								
-500	207	212.9																																																								
0	207	212.0																																																								
500	207	211.1																																																								
1000	205	210.2																																																								
2000	204	208.4																																																								
2500	203	207.5																																																								
3000	200	206.6																																																								
3500	197	205.7																																																								
4000	195	204.8																																																								
4500	194	203.9																																																								
5000	194	203.0																																																								
5500	193	202.0																																																								
6000	192	201.1																																																								
6500	191	200.2																																																								
7000	190	199.3																																																								
7500	188	198.3																																																								
8000	187	197.4																																																								
<p>Programming for hot water tank temperature setting (also dispense temperature) and display units (°C or °F)</p> <p>PROGRAMMED Tank Temperature and Dispense Temperature are the same</p>	<p>Internal tank functions Verify probe readings for tank temperature, and water level. Show status of liquid level probes for tank water level.</p> <p>Touch pad verification (instructions in following section)</p>	<p>Output functions And test points.</p> <p>Will activate selection for 2-3 seconds.</p>	<p>Service technician error report for fault and software diagnostics and upgrade</p>																																																							

<h3>Error Code Screen</h3>																											
	<p>Error codes are cleared by selecting the "OTHER" screen. Scroll and press the upper control to "Reset Error Codes".</p> <p>Press the lower selector to clear.</p> <table border="0"> <thead> <tr> <th colspan="2">Error codes</th> </tr> </thead> <tbody> <tr><td>050</td><td>Shorted temperature probe - tank</td></tr> <tr><td>051</td><td>Open temperature probe - tank</td></tr> <tr><td>052</td><td>Outlet temperature sensor shorted</td></tr> <tr><td>053</td><td>Outlet temperature sensor open</td></tr> <tr><td>100</td><td>Initial fill error (not filled in 6 minutes after power up)</td></tr> <tr><td>101</td><td>Error on refill (The tank has not refilled in 1 minutes- Possibly faulty solenoid or issue with the water line)</td></tr> <tr><td>102</td><td>Unwanted fill (Possibly tank or internal leak)</td></tr> <tr><td>103</td><td>Overflow error (float switch activated)</td></tr> <tr><td>104</td><td>Lower (longer) liquid level probe fault</td></tr> <tr><td>105</td><td>Upper (shorter) liquid level probe fault</td></tr> <tr><td>200</td><td>Flat line temperature</td></tr> <tr><td>201</td><td>Heater open (heater or triac failure)</td></tr> </tbody> </table>	Error codes		050	Shorted temperature probe - tank	051	Open temperature probe - tank	052	Outlet temperature sensor shorted	053	Outlet temperature sensor open	100	Initial fill error (not filled in 6 minutes after power up)	101	Error on refill (The tank has not refilled in 1 minutes- Possibly faulty solenoid or issue with the water line)	102	Unwanted fill (Possibly tank or internal leak)	103	Overflow error (float switch activated)	104	Lower (longer) liquid level probe fault	105	Upper (shorter) liquid level probe fault	200	Flat line temperature	201	Heater open (heater or triac failure)
Error codes																											
050	Shorted temperature probe - tank																										
051	Open temperature probe - tank																										
052	Outlet temperature sensor shorted																										
053	Outlet temperature sensor open																										
100	Initial fill error (not filled in 6 minutes after power up)																										
101	Error on refill (The tank has not refilled in 1 minutes- Possibly faulty solenoid or issue with the water line)																										
102	Unwanted fill (Possibly tank or internal leak)																										
103	Overflow error (float switch activated)																										
104	Lower (longer) liquid level probe fault																										
105	Upper (shorter) liquid level probe fault																										
200	Flat line temperature																										
201	Heater open (heater or triac failure)																										
<h3>Touch pad function test</h3>																											
	<p>Tests the Upper and Lower touch pads for proper sensitivity. Use after servicing to check functionality of the touch pad. When selected - the indicator will display the key being touched.</p> <p>The example to the right shows the UPPER -White key is active.</p> <p>Touching the LOWER-Red pad will highlight the red key marker</p> <p>Circuit logic digits may display variable number. Used for manufacturing</p>																										





REVISIONS					
REV	DATE	ECD NO	DESCRIPTION	BY	APP
A	08/23/2011	N/A	ORIGINAL	AG	

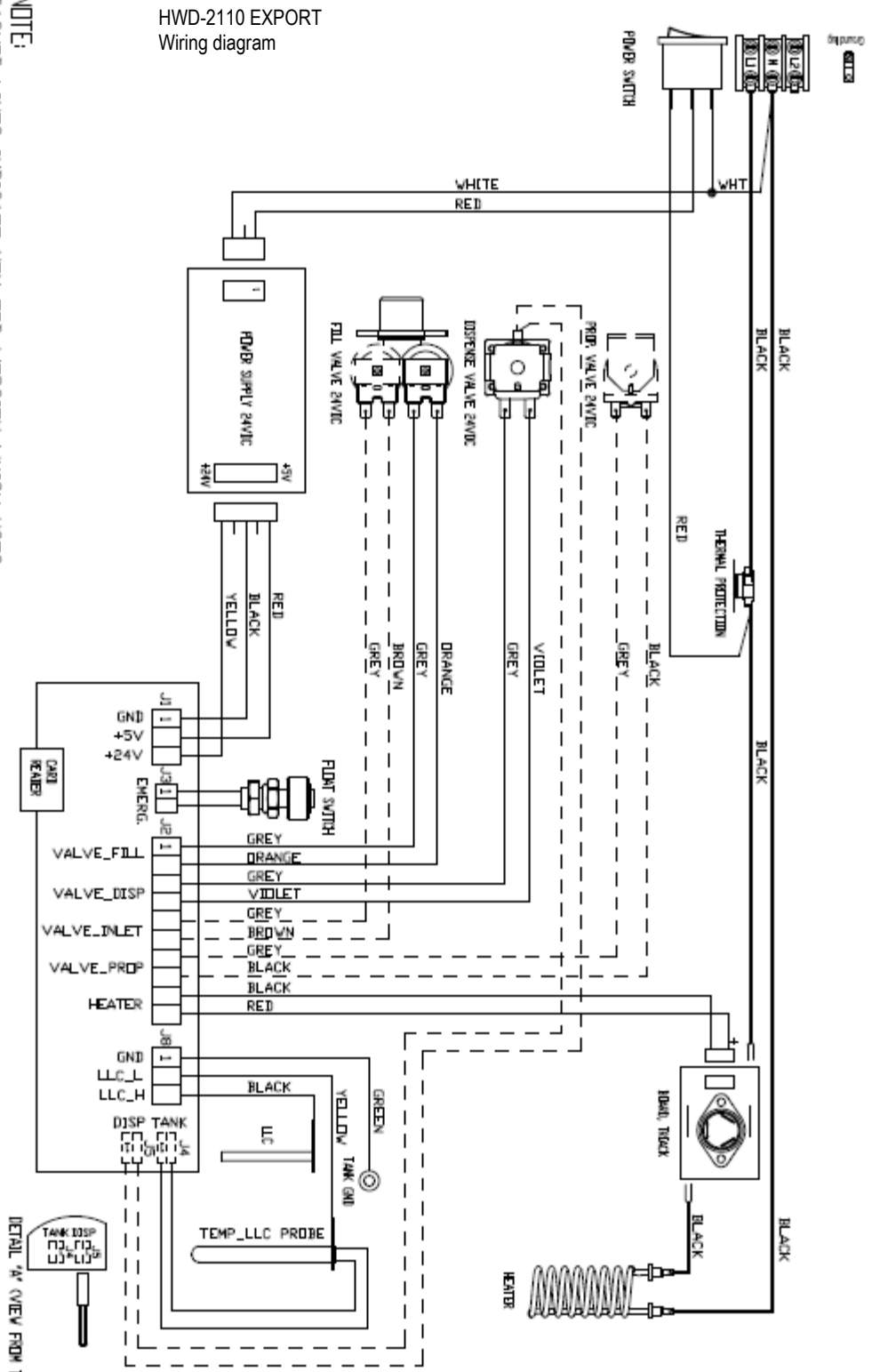

HWD-2110 EXPORT  
Wiring diagram

NOTE:  
DASHED LINES INDICATE NON TOD VERSION WHICH USES  
SINGLE VALVE AND NO PROPORTIONAL VALVE, DASHED WIRES  
IN THE ELECTRICAL HARNESS AND SENSOR ASSY 1102,00151,00 ARE NOT USED  
HOOK RESISTOR ASSY PN:1059,00002,00 IN PLACE FOR SENSOR ASSY ON THE BOARD  
SEE DETAIL 'A'

TOLERANCES		REVISIONS		DRAWN BY		DATE	
EXCEPT AS NOTED	NO.	DATE	BY	DATE	BY	DATE	BY
DECIMAL	A	08-23-2011	AG				
+/ - .005	B	X					
FRACTIONAL	C	X					
+/ - 1/64"	X	X					
ANGULAR	X	X					
+/ - 1/2 DEG	C	X					

**PETCO**  
 THE EXPORT BRAND OF  
 PETCO STORES, INC.  
 1401.00037.00

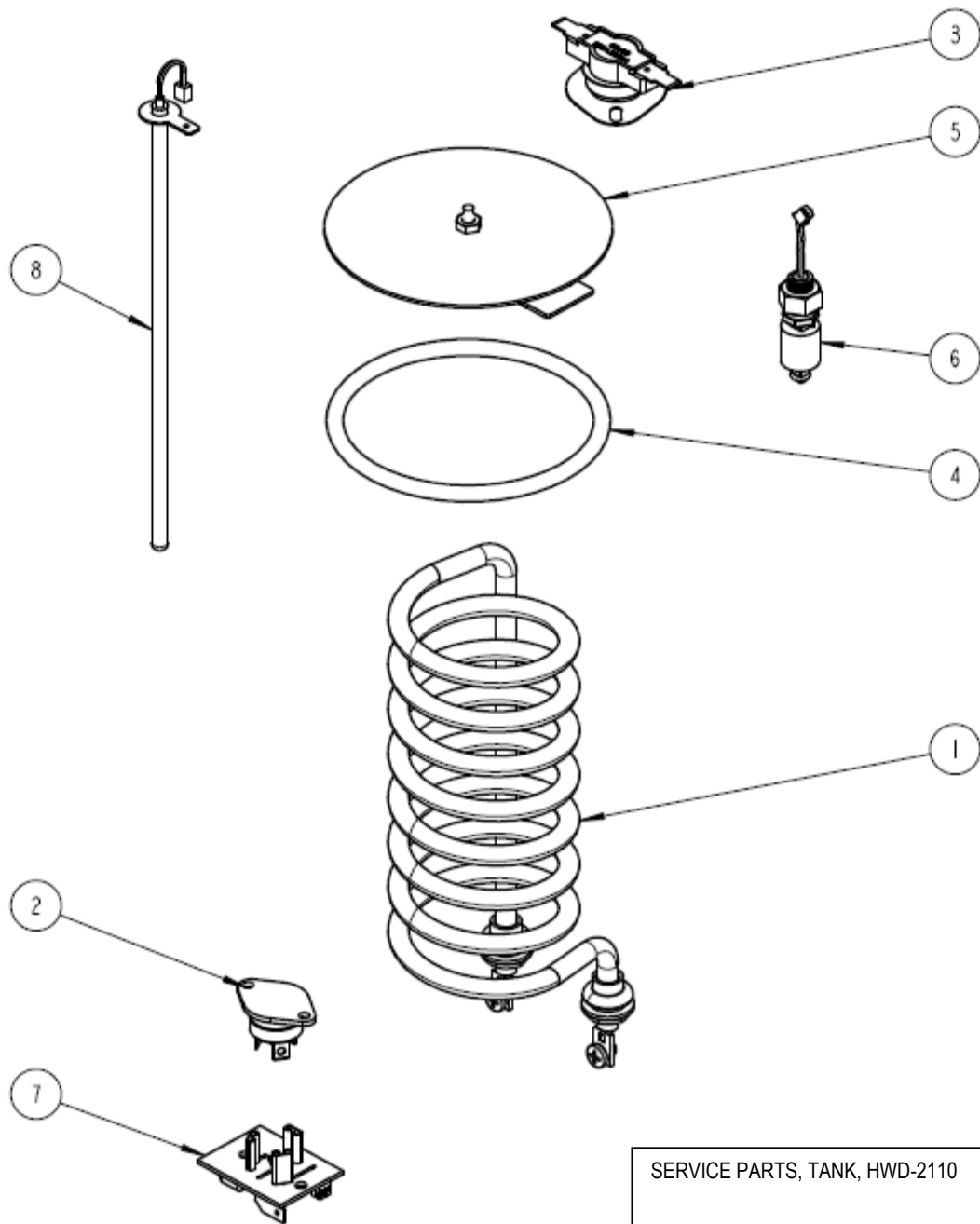

**PARTS LIST FOR HWD-2110 Hot Water Tank Drawing 1104.00028.00**

ITEM#	PART#	DESCRIPTION	QTY
1	1107.00013.00	HEATER ASSEMBLY, IMMERSION <b>5000W/240VAC</b>	1
2	1059.00001.00	TRIAC 40A, 600V	1
3	1053.00004.00	THERMOSTAT, SINGLE SHOT, 25A	1
4	1024.00007.00	O-RING, DASH #344, TANK COVER	1
5	1102.00007.00	TANK COVER ASSEMBLY	1
6	1054.00006.00	FILL SENSOR, HWD	1
7	1051.00016.00	BOARD, TRIAC DRIVE WITH RC FILTER	1
8	1102.00161.00	PROBE ASSEMBLY, TEMP. AND LLC, HWD-2105	1



PARTS LIST FOR HWD-2110 With TOD Service Parts Drawing 1109.00033.00			
Item #	Part Number	Description	Qty
1	1023.00136.00	LEG HWD-2100	4
2	1023.00146.00	TOP COVER HWD-2110	1
3	1023.00147.00	PLUG, TANK SERVICE DRAIN for 18GA AND UP BODY	1
4	1024.00040.00	CARD PLUG, HWD-2100	1
5	1025.00040.00	TUBE, 1/4" OD X .125" ID X 16" LG, VENT	1
6	1025.00041.00	TUBE, 3/4" OD X 1/2" ID X 2.75" LG, DISPENSE	1
7	1025.00042.00	TUBE, 5/8" OD X 3/8" ID X 2" LG, BOTTOM TANK	1
8	1025.00049.00	TUBE, SILICONE, 5/16" OD X 3/16" ID X 12.69" LG, TANK VENT	1
9	1025.00051.00	TUBE, 5/8" OD X 3/8" ID X 6.44" LG, DOUBLE VALVE	1
10	1025.00052.00	TUBE, 5/8" OD X 3/8 ID X 8.19" LG, DRAIN	1
11	1029.00002.00	FITTING, HOSE BARB TEE, SIZE 3/8" , NYLON	1
12	1029.00017.00	FAUCET, SILICONE, HWD-2100	1
13	1029.00023.00	FITTING, SINGLE BARBED ELBOW, 1/4", KYNAR	1
14	1052.00010.00	TERMINAL BLOCK, 3 POLE, 30 AMP, 10-22 AWG	1
15	1057.00043.00	SOLENOID VALVE, SINGLE, 180 DEG, 24VDC	1
16	1058.00020.00	SWITCH, POWER ROCKER RED, ILLUMINATED 240V	1
17	1063.00008.00	CORD, POWER, N6/30 PLUG, 30A/250VAC, SJTO 12/3,	1
18	1065.00002.00	CONNECTOR, COPPER LUG	1
19	1086.00002.00	CLAMP, HOSE, SIZE "G" NYLON	2
20	1086.00003.00	UNICLAMP, 15.9 HOSE OD CLAMP	6
21	1086.00008.00	CONNECTOR, CLAMP, FOR NON-METALIC CABLE, 3/4"	1
22	1102.00153.00	FRONT PANEL TOP, ASSEMBLY HWD-2100	1
23	1102.00156.00	DRIP TRAY ASSEMBLY, HWD - 2100	1
24	1102.00159.00	POWER SUPPLY ASSEMBLY, HWD-2100	1
25	1102.00160.00	BOARD AND DISPLAY ASSEMBLY, HWD-2100	1
26	1102.00164.00	ADAPTER ASSEMBLY, 3/4" BSP X 1/4 SAE FLARE	1
27	1102.00167.00	DISPENSE VALVE ASSEMBLY, HWD-2100	1
28	1104.00028.00	TANK ASSEMBLY, 5000W/240V, HWD-2110	1
29	1402.00027.00	HARNESS, HWD-2110, SINGLE HEATING ELEMENT	1